

HÄFELE

Let's
Reimagine

TM



www.hafeleindia.com

KITCHEN SINKS & FAUCETS



Introduction

Dear Customers,

Häfele has pioneered the way interior fittings are sold across the globe for many years now. Being a German company our foremost concern has always been to offer our customers products that are at the cutting edge of functionality and design; and backed by the highest standards in Customer Service. In our markets, we are increasingly being recognized as a one-stop interior specialist brand that can enable functionality for any interior design through a holistic solution offering, be it door hardware, furniture or kitchen fittings, sliding systems, built-in appliances, bathroom solutions, furniture lighting and interior surfaces.

Our core competency in kitchen fittings has been a trigger point for us to engineer a range of products for the washing area of the kitchen. Through this catalogue, we present to you a complete and elegant range of kitchen sinks and faucets, backed by advanced technologies and rendered in latest designs, materials and colours. This range of kitchen products comes with the highest standards of quality backed by numerous testing and certifications. What's more is that what we bring to you from across the globe in the form of technology and design has been carefully researched and engineered to ably suit Indian kitchen environments.

Häfele presents to you the patented Silgranit sinks from BLANCO, Germany that come in a range of elegant colours, ergonomic shapes and a multitude of sizes to choose from. Our range of SILGRANIT™ PuraDur™ kitchen sinks is backed by decades of experience and research in market knowledge, engineering proficiency and latest technologies, just so we can adapt it to your likeness and needs. The SILGRANIT™ material is a unique and patented technological break-through that combines the hardest elements found in natural granite, acrylic, ceramic and colour pigments to give you the result of a kitchen sink surface you may have never seen before. Along with this range, comes the sheer elegance in designing competency through our range of BLANCO faucets available in chrome plated finish as well as colours that match the look and texture of our SILGRANIT™ sinks. In terms of quality and technology, these faucets are extensively tested and certified to provide maximum safety in health and hygiene and provide longevity in use thanks to the long-life ceramic disc cartridges which provide for a precise adjustment of the water amount and temperature.

Through this range, we also present to you elegant design and fashion in the form of kitchen faucets from Italy. Backed by years of research and experience, this range is a synonym of quality and safety for you, our customer. These faucets are engineered with an Anti-Lime pure water outlet design where the aerator reduces the possibility of lime formation & increases the lifespan of your faucet. The in-built Water Sense Technology saves 20% more water than similar products in the market. Available in classic Italian designs or modern contemporary lines, you can't miss your favourite pick from this range.

Finally, our in-house range of stainless steel sinks presents itself with inherent properties and features that are most suitable for Indian kitchens where washing and cleaning is an aggressive activity and the use of water is much more than any of our global counter parts. The ARGENTO series is an elegant range of hand-crafted sinks that comes in different designs and sizes to choose from. Our range of punch-bowl sinks under the SPLASH series is carefully engineered to withstand extreme conditions of use. Taking into account the constant exposure of a sink to dampness and moisture, our Stainless steel sinks are coated with Asphalt at the base of the bowl protecting them from condensation or corrosion. A special sound suppression pad of 0.5 to 0.8mm thickness is integrated into the sink bowl which enables these Sinks to absorb excessive noise when vessels are being washed.

So come and experience the elegance of designs and the convenience of functionality of this exclusive range. Visit any of our Design Showrooms for a better understanding and detailed dialogue. We are taking all the necessary precautions at our end to make your visit a safe and fruitful experience.

Enjoy!

Jurgen Wolf.
Managing Director
Häfele South Asia.

Hafele

Reassuring Expertise



"For almost 10 decades, we've been helping people make more of their homes.

Established in Germany, and now operating worldwide, we specialise in the fittings, hardware and systems that improve the way your home, works. So when you choose our products as part of your new or reformed home, you know you're getting the benefit of extensive knowledge and decades of experience.

And we're still a family business, owned and managed by family members who really care about the products and service we provide. You can rely on our commitment to the

highest standards of quality and reliability, founded on a long tradition of German engineering where attention to detail is second nature.

All our home improvement ideas are built to last – day in, day out – we want you to get the very best from every corner of your home, for many years to come."

Häfele Worldwide



With its origin in 1923 in a small town named 'Nagold' from the Swabian region of Germany that nurses a passion for hardware technology, it is no surprise that Häfele has lived up to its roots through a successful presence in the architectural and furniture hardware industry for over 9 decades now. Today, Häfele's worldwide penetration includes 38 subsidiaries across Europe, America, Asia, Australia and New Zealand. With these subsidiaries and numerous other sales organisations, Häfele operates in over 150 countries. The Häfele headquarters, 4 manufacturing units and 10 sales offices are located within Germany; while 1 manufacturing unit is located at Budapest, Hungary. The company also owns one of the largest and most sophisticated warehouses in its home country. The Häfele worldwide workforce is empowered by a base of over 8100 employees.

The group services over 150,000 customers across the globe through its extensive range of hardware products and a comprehensive logistics system. In addition to this, Häfele also provides consultative services to its customers, educating and advising them about buying the correct hardware as per their requirements. With this level of market penetration and ability to handle worldwide demand, it comes as no surprise that the company is an authority in the segment of home interior solutions; what is pleasantly surprising, though, is that in spite of its size, Häfele still remains a family owned and run business with a unique, friendly and value-centric work culture which is strongly followed among all its subsidiaries.

Hafele India

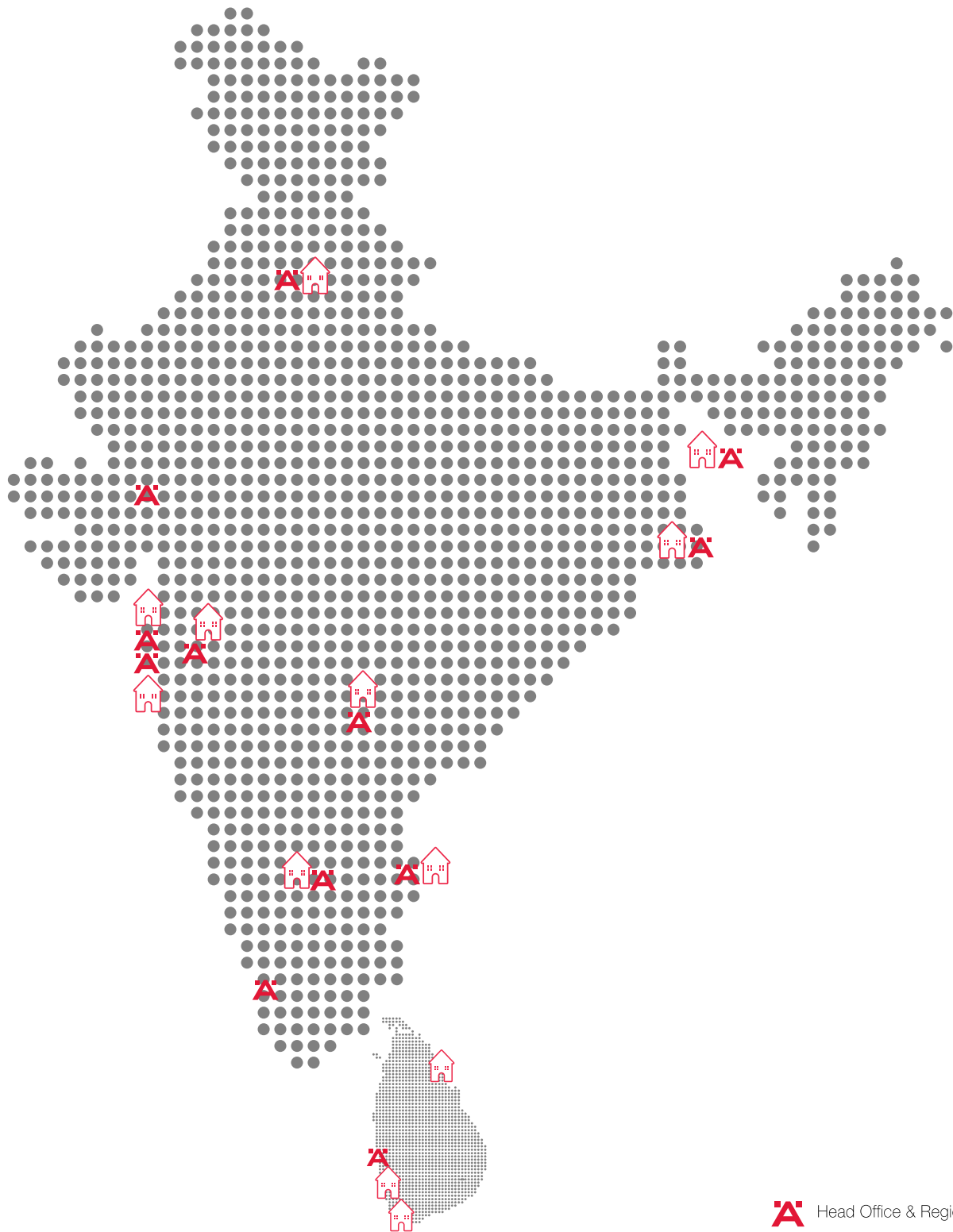

 Head Office & Regional Offices

 Hafele Design Showrooms



Häfele India is a wholly-owned subsidiary of the Häfele Global network and has been operating in India since 2003 under the leadership of Mr. Jürgen Wolf (Managing Director). The ability of the company to understand the diverse Indian market has made it an authority in the field of architectural hardware, furniture and kitchen fittings and accessories. The company also has a strong presence in synergized product categories namely Home Appliances, Furniture Lighting, Sanitary and Surfaces catering to the focused demand from these industries.

The subsidiary has a strong nation-wide presence with offices in Mumbai, Pune, Ahmedabad, Bangalore, Chennai, Hyderabad, Delhi, Kolkata and Cochin. It has full-scale operations in Sri Lanka and Bangladesh with Regional offices and Design Showrooms in both the countries; and has also spread its operations to other regions of South Asia including Nepal, Bhutan and Maldives.

Häfele's design showrooms are hubs of international home interior trends and cutting edge designs presented in a world-class environment, where customers can see home solutions in their inherent applications. These showrooms function as a one-stop-shop for all home interior and improvement needs - from providing in-depth technical advice to kitchen and wardrobe designing services through a team of experts stationed at the showroom.

Häfele India services its customers with a base of over 1300 employees, a well-networked Franchise base of over 190 shops along with over 500 direct dealers and 90+ distributors who in turn cater to over 8000 satellite dealers. The subsidiary has a sophisticated Logistics centre in Mumbai along with distribution centres in Delhi, Bangalore, Kolkata and Colombo respectively.



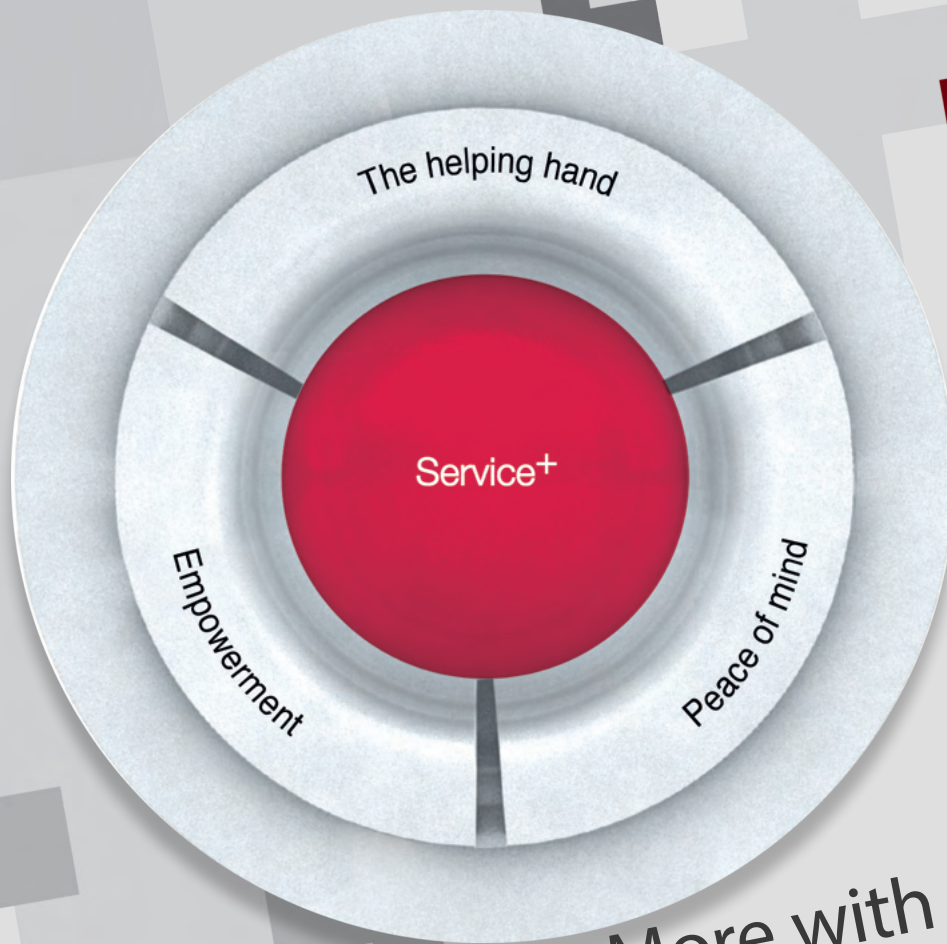

Experience More with **Service+**

Our customers' working environment is becoming increasingly complex and their market is becoming ever more demanding. This drives our motivation to do everything in our power to help our customers be successful. And to demonstrate that Häfele is the right partner in these challenging times, we want to accompany our customers throughout their entire business process and give them added strength in every phase of their business. We don't just want to sell our products, we also want to provide the highest level of service.

We have now divided our services into two categories: Standard Services which we provide to our customers as a matter of course when they choose our products. For example, a high availability of our goods and punctual delivery. And then there is Service+ which constitutes of services that give our customers considerable added value in terms of building expertise, increasing productivity or providing individual customised solutions. These services require a considerable amount of time and effort to develop and implement and are designed to enable our customers to regard them as worthwhile investments.

The aim is to create solid long-term foundations for our comprehensive service promise and to make Häfele an indispensable partner for our customers. The focus here lies not so much on us and on what we do – but rather, on the benefits derived by our customers. We want to empower them with opportunities to develop and expand their skills – both as masters of their trade and as entrepreneurs. We want to support them in the planning and realisation of their projects and relieve them of as much work as possible, thereby providing them with a helping hand to use their most valuable resource – time – as efficiently as possible. And we aim to give our customers peace of mind and the assurance that even after the end of a successful project completion, we will continue to be there for them as a reliable partner, shouldering responsibility.



The Pillars of **Service+**

In order to support you as comprehensively as possible, we have assigned the Plus Services to individual stages of your work process in a total of four themed pillars. We start with the transfer of knowledge and accompany you via planning and production to installation and maintenance.



Empowering customers with
Service+ Knowledge

Includes service offerings that provide inspiration and expertise to our customers about the Häfele product range. Through these, we enable our customers to use Häfele products profitably and at the same time remain at the cutting edge of technological development. One example of this is the Häfele Academy, which imparts knowledge about complex products and new technologies to our customers via seminars and trainings.

Providing a helping hand to customers with
Service+ Planning & Customised

Includes service offerings like space, design planning and customisations that make life easier for our customers and support their design vision. An example of this is Häfele's Lighting Design Service which helps our customers curate a lighting plan, following a customised approach, that enhances and brings out the true functionality of the interior space as per requirement.



Lending a "Peach-of-mind" experience through
Service+ Assist

Includes service offerings that provide support and assistance to our customers, whether digitally or on site. An example of this is the complete assembly and installation service for more complex and maintenance-intensive products done by our Meister certified and trained technicians.



Meister Service



Bought products from Häfele and got questions about how to use them correctly? Do you require technical support? Our competent technicians would be pleased to help you out with the help of Meister Service.

Meister Service offers complete installation of key hardware products from Häfele, by 'Meister Certified' and trained service technicians from the company directly, at a nominal service charge. This service is available for select products from categories like Kitchen Solutions, Sliding Solutions, Door Hardware, Furniture Fittings and Lighting Solutions.

Key benefits of this initiative:

- Accurate installation of products as per standards and specifications
- Optimum functionality through accurate installations
- Less hassles of product replacements
- A peace-of-mind experience for customers using Häfele products



To learn more about Meister Service please contact our team by scanning this QR code or call us at +91 1800 266 6667

CONTENTS

INTRODUCTION

PAGE

3-13

BLANCO SILGRANIT
SINKS & FAUCETS

PAGE

14-53

HAFELE
KITCHEN FAUCETS

PAGE

54-81

BLANCO STEEL ART-
SINKS

PAGE

82-96

STAINLESS STEEL
SINKS & TAPS

PAGE

97-113

BLANCO UNIT

drink. prep. clean.



CONTENTS

BLANCO
Silgranit Kitchen Sinks & Faucets

PAGE **14-53**



27	BLANCONAYA XL9
28	BLANCONAYA 8 S
29	BLANCOSONA 8 S
30	BLANCOMETRA 8 S
31	BLANCO SONA 6 S
32	BLANCOMETRA 9
33	BLANCOPLEON 9
34	BLANCOMETRA XL 6 S
35	BLANCORONDO
38	BLANCOPLEON 8
39	BLANCONAYA 6
44	BLANCOCARENA-S-VARIO
45	BLANCOTIVO-S
46	BLANCOMIDA-S
47	BLANCOLINUS-S
48	BLANCOMILI
49	BLANCOMILA-S
50	BLANCOMIDA
51	BLANCODARAS-S
52	BLANCODARAS



ENDULGE IN THE PURITY OF DESIGN AND TEXTURE

Kitchen sinks that define unbeatable standards of design, functionality and maintenance.

Our range of **SILGRANIT™** kitchen sinks from BLANCO, Germany is backed by 60 years of experience and research in market knowledge, engineering proficiency and latest technologies, just so we can adapt it to your likeness and needs. The SILGRANIT material is a unique and patented technological break-through that combines the hardest elements found in natural granite, acrylic, ceramic and colour pigments to give you the result of a kitchen sink surface you may have never seen before.



Advantages of SILGRANIT™ sink

- Outstanding easy-to-care feature
- Non-porous sealed surface that's easy to clean
- Superior durability
- Patented hygiene protection formula
- Optimum space utilization for more comfort
- Resistant to scratches and harsh conditions
- Material and colour choices that enhance interiors

Today, BLANCO has produced more than 40 million sinks, and is recognized as a world leader in quality, innovation and unsurpassed service. Long gone are the times when a sink was merely used for function. These days, it can be the muse for a kitchen – or perhaps an entire home. Because of BLANCO's dedication to quality, every sink is inspected multiple times before earning the BLANCO name, it's just a part of their commitment to craft. BLANCO commits itself to respect ethical business principles and since 1994 has been a member of the Caux Round Table (CRT), an international network of principled business leaders and companies working to promote a moral capitalism

BLANCO turns a sink into a sink centre. Tips for making the right choice



Optimum space utilisation for more comfort

BLANCO offers solutions for any size of sink cabinet. A cabinet width of 60 cm is ideal for sinks with a main and additional bowl



Ergonomics and functionality

The main and additional bowls and accessories are designed to match each other perfectly. Comfort solutions – such as the AXial concept – help to achieve efficient working.



Cleaning made easy

The surfaces of sinks and mixer taps are wonderfully easy to clean. Special materials help to repel dirt and water.



Mixer taps by BLANCO

BLANCO offers a wide selection of designs of high functionality. Certified in accordance with the strict quality criteria of independent test institutes, they meet the highest requirements for safety and hygiene.



Material and colour add highlights

The right combination of sink and mixer tap creates an ambience that matches any home living style.

BLANCO EasyCare – Care is more than a superficial matter



Easy care of Maintenance

The material contains water and dirt repellent agents - making the sink easy to care for.



BLANCO CARE

Care products from BLANCO are specially designed to suit the respective materials. All conceivable problems can be dealt with - from scratches to limescale deposits and fingerprints to rust, metal abrasion and discolouration.



BLANCO WARRANTY

offers 10 years* warranty on manufacturing defect or faulty workmanship on BLANCO products
* T & C apply

Simply quicker to clean

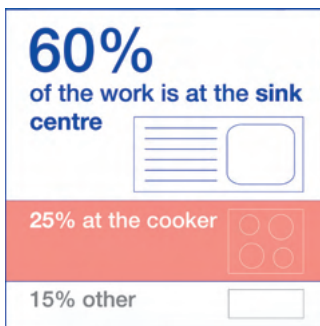

An independent survey proves it: **the heart of every kitchen is the sink. Over 60% of the work is done here, despite dishwashers!** This creates a great deal of dirt, of course. And this must be cleaned away. But this costs time. This is a great deal to expect but, at BLANCO, it is precisely this which is the driving force behind our developments. **We want to make kitchen chores as simple and as easy as possible.**

BLANCO EasyCare is the name behind this concept, a superior product concept:

Sinks, which are simply easier to clean!

BLANCO sinks are the right choice for:

- the degree of work facilitation
- the long term value of the kitchen
- the pleasure from and in the kitchen





SILGRANIT™

Easy to maintain and long-lasting

Thanks to the excellent material properties, SILGRANIT™ offers an ease of care and **level of resistance that has never been offered before** for coloured composite sinks.

Unsurpassed scratch resistance

Unsurpassed resistance to breakage

Unsurpassed heat-resistance to 280°C

SILGRANIT™ is:

- 100% suitable for food use
- 100% acid resistant
- 100% non fading



Unique colour fidelity

There is a choice of **six delightful colours with the identical surface condition** in all, and all specially designed to match the BLANCO taps.



Material properties

The stony-silky, very finely pored and closed surface create a soft stone-like character that is soft to touch.

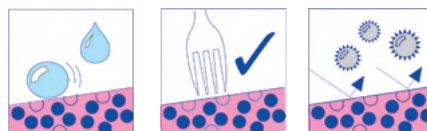



New and hygienic: the concealed C-overflow™ enhances the elegant look.



Perfect interplay: the newly designed accessories for optimum steam preparations at the sink.

Hafele's Range of Blanco Sinks comes with a unique colour fidelity and a host of contemporary colours, with identical surface conditions, specially designed to match the BLANCO taps

This section of the catalogue provides you with a detailed description of the features, product specifications and technical details of the models available in the range of BLANCO Kitchen Sinks and Mixer Taps

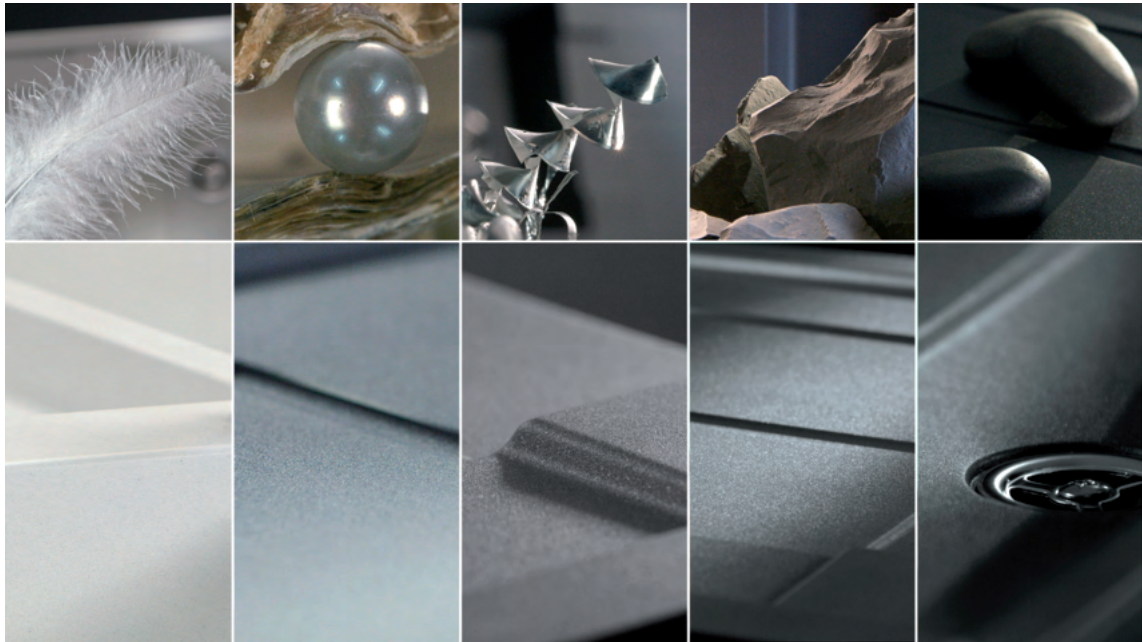

CombiColours

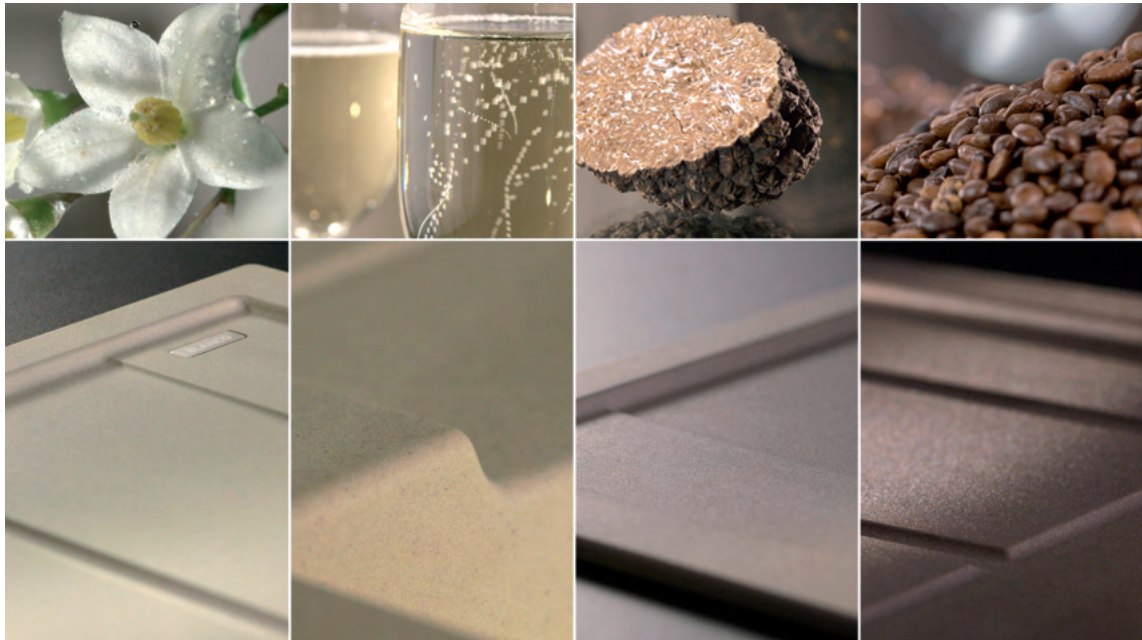

Material Features



Unsurpassed ease of cleaning



Unsurpassed scratch resistance



Unsurpassed resistance up to 280 °C



Unsurpassed resistance to breakage



Hygiene+Plus



100% food safe



100% acid resistant



100% non-fading

Hygienic Protection Formula



SILGRANIT™ with the patented hygienic protection formula.

Hygiene+Plus is a shield against dirt and bacteria, making cleaning easier. Thanks to its unique, patented hygiene protection formula **SILGRANIT™** is antibacterial.

Tests confirm that the unique built-in hygiene protection reduces bacterial growth by an average of 98 %.







BLANCO NAYA XL 9 - SILGRANIT™



Tailored To Your Style

- 100 % suitable for food use
- 100 % acid resistant
- 100 % non-fading

BLANCO NAYA XL 9

Specification

90 cm cabinet size



Finish: Anthracite
Article No. 570.25.320



Finish: Alu metallic
Article No. 570.25.920



Finish: White
Article No. 570.25.720



Finish: Jasmine
Article No. 570.25.620



Finish: Rocky Grey
Article No. 570.25.520



Finish: Coffee
Article No. 570.25.820

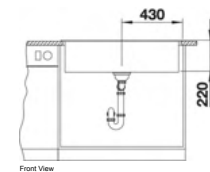
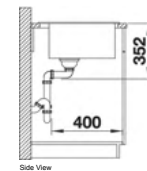
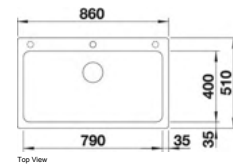

Bowl depth: 220mm
= Pre-drilled holes for
○ knock-out at site

Overall Size(mm/inch): 860x510 / 33.86"x20.08"

Bowl Size(mm/inch): 790x400/ 31.10"x15.75"

Depth size(mm/inch): 220/ 8.66"

Scope of supply: waste fitting with space-saving pipe, two 3 1/2" basket strainers

Optional accessories



BLANCO NAYA 8 S - SILGRANIT™



Tailored to your style

- Balanced, modern lines
- Generously designed main and additional bowl
- Functionally designed drainer with depositing and working area
- Spacious tap ledge with room for a mixer tap and soap dispenser
- For the 80 cm sink cabinet

BLANCO NAYA 8 S

Specification

80 cm cabinet size



Finish: Anthracite
Article No. 565.71.350



Finish: Alu Metallic
Article No. 565.71.950



Finish: White
Article No. 565.71.750



Finish: Jasmine
Article No. 565.71.650



Finish: Rock Grey
Article No. 565.71.550



Finish: Coffee
Article No. 565.71.850

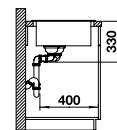
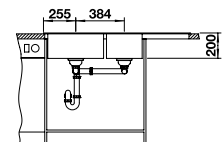
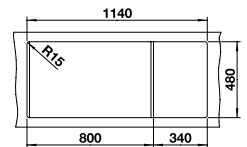
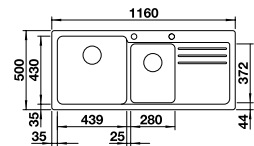

Overall Size(mm/inch): 1160mmx500mm / 45.66" x 19.68"

Bowl Size(mm/inch): 439x430mmx200mm / 17.28" x16.92" x 7.87"

Half bowl size(mm/inch): 280x372mmx200mm / 11.02" x 14.65" x 7.87"

Scope of supply: waste fitting with space-saving pipe, two 3 1/2" basket strainers

Optional accessories



Outlet Cover CapFlow
565.69.890



Odour Trap
565.69.039

BLANCO SONA 8 S - SILGRANIT™



Tailored to contemporary kitchens

- Modern, independent design
- Two bowls of the same size for maximum comfort when washing dishes
- Harmoniously integrated, lower additional outlet made of SILGRANIT™
- Generous, strikingly-profiled tap ledge
- Specially for the 80-cm base cabinet

BLANCO SONA 8 S

Specification

80 cm cabinet size



Finish: Anthracite
Article No. 567.70.300



Finish: Alu Metallic
Article No. 567.70.900



Finish: White
Article No. 567.70.700



Finish: Jasmine
Article No. 567.70.600



Finish: Rock Grey
Article No. 567.70.500



Finish: Coffee
Article No. 567.70.800

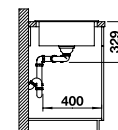
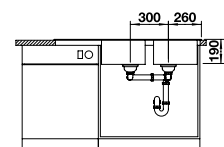
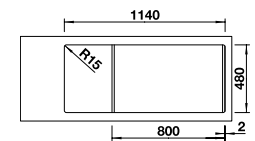
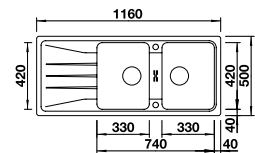

Overall Size(mm/inch): 1160mmx500mm / 45.66" x19.68"

Each Bowl Size(mm/inch): 330mmx420mm / 13"x16.53"

BOWL DEPTH = 190mm / 7.48"

Scope of supply: waste fitting with space-saving pipe, two 3 1/2" basket strainers

Optional accessories



Outlet Cover CapFlow
565.69.890



Odour Trap
565.69.039

BLANCO METRA 8 S - SILGRANIT™



Clean lines maximum comfort

- Young, straight-lined design
- Attractive line of sinks in the medium price category
- Particularly spacious bowls provide an unsurpassed amount of room
- The additional bowl provides a high degree of comfort
- Available in all SILGRANIT™ colours
- Can be installed either way round and also as undermount sink
- Pre-drilled holes for knock-out at site

BLANCOMETRA 8 S

Specification

80 cm cabinet size



Finish: Anthracite
Article No. 565.70.340



Finish: Alu Metallic
Article No. 565.70.940



Finish: White
Article No. 565.70.740



Finish: Jasmine
Article No. 565.70.640



Finish: Rock Grey
Article No. 565.70.540



Finish: Coffee
Article No. 565.70.440

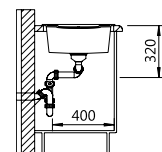
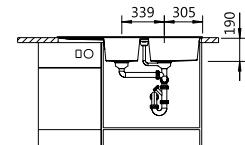
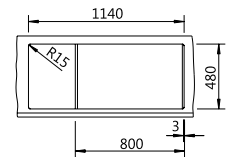
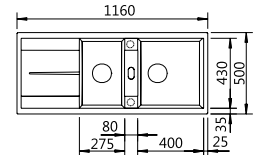

Overall Size(mm/inch): 1160x500x190mm & 190mm / 39.37" x 19.68"x7.48" & 7.48"

Bowl Size(mm/inch): 430x400x190mm / 16.92" x 14.17"x7.48"

Half bowl size(mm/inch): 285x170x190mm / 11.22" x 6.69" x 7.48"

Scope of supply: waste fitting with space-saving pipe, two 3 1/2" basket strainers

Optional accessories



Outlet Cover CapFlow
565.69.890



Odour Trap
565.69.039

BLANCO SONA 6 S - SILGRANIT™



Tailored to contemporary kitchens

- Modern, independent design
- Kitchen tasks are made much easier by the roomy main bowl and a practical additional bowl
- Generous, strikingly-profiled tap ledge
- Specially for the 60-cm base cabinet

BLANCOSONA 6 S

Specification

60 cm cabinet size



Finish: Anthracite
Article No. 567.70.310



Finish: Alu Metallic
Article No. 567.70.910



Finish: Rock Grey
Article No. 567.70.510



Finish: Coffee
Article No. 567.70.810

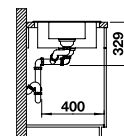
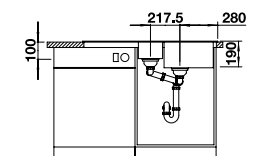
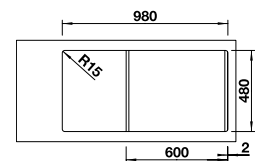
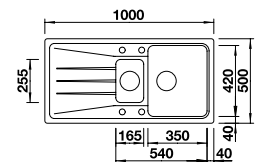

Overall Size(mm/inch): 1000mmx500mm / 39.37" x19.68"
Bowl Size(mm/inch): 350x420mmx190mm / 13.77"x16.53"x7.48"
Half bowl size(mm/inch): 165x255mmx100mm / 6.49"x10.04"x3.93"

Scope of supply: waste fitting with space-saving pipe, two 3 1/2" basket strainers

Optional accessories



Outlet Cover CapFlow
565.69.890



Odour Trap
565.69.039

BLANCO METRA 9 - SILGRANIT™



Clean lines maximum comfort

- Young, straight-lined design
- Attractive line of sinks in the medium price category
- Particularly spacious bowls provide an unsurpassed amount of room
- Large tap ledge for installation of mixer tap and soap dispenser
- Aesthetic low-profile rim design
- Pre-drilled holes for knock-out at site

BLANCOMETRA 9

Specification

90 cm cabinet size



Finish: Anthracite
Article No. 565.70.352



Finish: Alu Metallic
Article No. 565.70.952



Finish: White
Article No. 565.70.752



Finish: Jasmine
Article No. 565.70.652



Finish: Rock Grey
Article No. 565.70.552



Finish: Coffee
Article No. 565.70.452

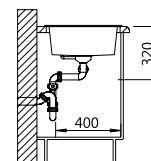
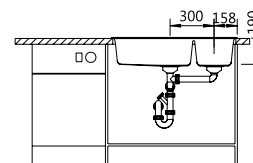
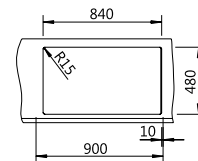
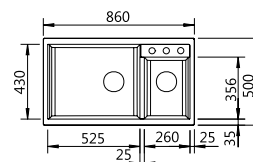

Overall Size(mm/inch): 860x500mmx 190mm / 33.85" x 19.68"x7.48"

Bowl Size(mm/inch): 495x340mm / 20.66" x 16.92"

Half bowl size(mm/inch): 356x260mm / 14.01" x 10.23"

Scope of supply: waste fitting with space-saving pipe, two 3 1/2" basket strainers

Optional accessories



Outlet Cover CapFlow
565.69.890



Odour Trap
565.69.039



Plug for Tap Hole
565.69.909

BLANCO PLEON 9 - SILGRANIT™



Pure elegance - rich volume

- Timelessly elegant, straight-lined design
- Main bowl and additional bowl with maximum volume thanks to particularly deep bowls
- Spacious tap ledge
- Easy to clean, flowing transition from the sink's rim to the tap ledge
- Elegant and hygienic: the concealed overflow C-over flow™
- Pre-drilled holes for knock-out at site

BLANCO PLEON 9

Specification

90 cm cabinet size



Finish: Anthracite
Article No. 567.68.320



Finish: Alu Metallic
Article No. 567.68.920



Finish: White
Article No. 567.68.720



Finish: Jasmine
Article No. 567.68.620



Finish: Rock Grey
Article No. 570.25.540



Finish: Coffee
Article No. 570.25.840



Finish: Tartufo
Article No. 570.25.040

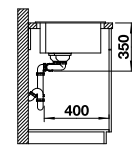
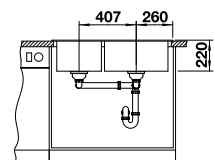
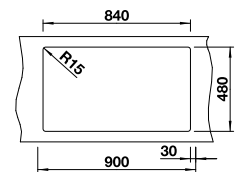
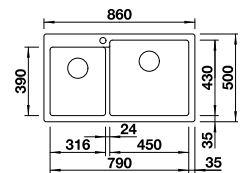

Overall Size(mm/inch): 860x500mmx 220mm / 33.85"x19.68"x8.66"

Bowl Size(mm/inch): 450x430mm / 17.71"x16.92"

Half bowl size(mm/inch): 316x390mm / 12.44"x15.35"

Scope of supply: waste fitting with space-saving pipe, two 3 1/2" basket strainers

Optional accessories



Outlet Cover CapFlow
565.69.890



Plug for Tap Hole
565.69.909



Odour Trap
565.69.039

BLANCO METRA XL 6 S - SILGRANIT™



Clear outline with a hint of luxury and increased capacity

- Young, straight-lined design
- The unsurpassed capacity of the bowl provides more room to do the washing up
- Aesthetic low-profile rim design
- Can be installed either way round and also as under mount sink
- Cutting boards in various designs and crockery basket available as optional extras
- Pre-drilled holes for knock-out at site

BLANCOMETRA XL 6 S

Specification

60 cm cabinet size



Finish: Anthracite
Article No. 565.76.390



Finish: Alu Metallic
Article No. 565.76.990



Finish: White
Article No. 565.76.790



Finish: Jasmine
Article No. 565.76.690



Finish: Rock Grey
Article No. 567.67.590



Finish: Coffee
Article No. 565.76.890



Finish: Tartufo
Article No. 565.76.090

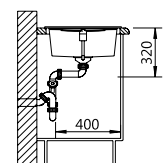
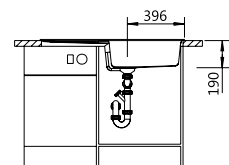
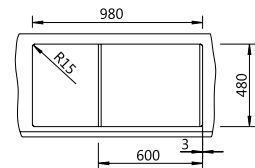
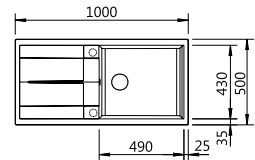

Overall Size(mm/inch): 1000x500mmx 190mm / 39.37" x 19.68" x 7.48"

Bowl Size(mm/inch): 490x430mm / 19.29" x 16.92"

Scope of supply: waste fitting with space-saving pipe, two 3 1/2" basket strainers

Optional accessories



Outlet Cover CapFlow
565.69.890



Odour Trap
565.69.039

BLANCO RONDO - SILGRANIT™



The sink for individualists

- Ideal solution for small kitchens
- Large bowl
- Optional accessory: crockery basket

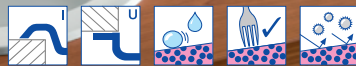

BLANCORONDO

Specification

45 cm cabinet size



Finish: Anthracite
Article No. 565.70.390



Finish: Alu Metallic
Article No. 565.70.990



Finish: White
Article No. 565.70.790



Finish: Jasmine
Article No. 565.70.690



Finish: Coffee
Article No. 565.70.490

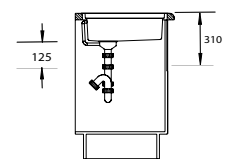
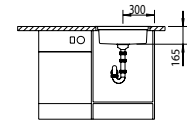
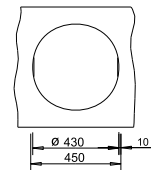
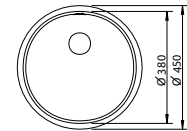

Ø Diameter(mm/inch): 450mm / 17.71"

Depth(mm/inch): 165mm / 6.49"

Scope of supply: waste fitting with space-saving pipe, two 3 1/2" basket strainers

Optional accessories



Outlet Cover CapFlow
565.69.890



Odour Trap
565.69.039

BLANCO UNIT
drink. prep. clean.



BLANCO UNIT
drink. prep. clean.



BLANCO PLEON 8 - SILGRANIT™



Pure elegance - rich volume

- Timelessly elegant, straight-lined design
- Single bowl with maximum volume thanks to particularly deep bowl
- Continuous, generous tap ledge
- Easy to clean, flowing transition from the sink's rim to the tap ledge
- Elegant and hygienic: the concealed overflow C-over flow™
- Pre-drilled holes for knock-out at site

BLANCO PLEON 8

Specification

80 cm cabinet size



Finish: Anthracite
Article No. 567.68.300



Finish: Alu Metallic
Article No. 567.68.900



Finish: White
Article No. 567.68.700



Finish: Jasmine
Article No. 567.68.600



Finish: Rock Grey
Article No. 570.25.530



Finish: Coffee
Article No. 570.25.830



Finish: Tartufo
Article No. 570.25.030

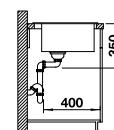
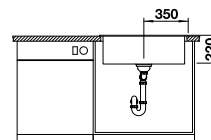
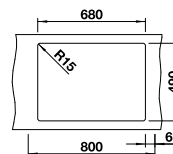
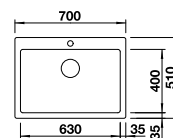

Overall Size(mm/inch): 700x510mmx 220mm / 27.55" x 20.07" x 8.66"
Bowl Size(mm/inch): 630x400mm / 24.80" x 15.74"

Scope of supply: waste fitting with space-saving pipe, two 3 1/2" basket strainers

Optional accessories



Outlet Cover CapFlow
565.69.890



Odour Trap
565.69.039



Plug for Tap Hole
565.69.909

BLANCO NAYA 6 - SILGRANIT™



Tailored to your style

- Balanced, modern lines
- Spacious, deep single bowl with integrated overflow and continuous tap ledge
- Sink comfort in a compact shape
- For the 60 cm base cabinet

BLANCONAYA 6

Specification

60 cm cabinet size



Finish: Anthracite
Article No. 565.71.330



Finish: Alu Metallic
Article No. 565.71.930



Finish: White
Article No. 565.71.730



Finish: Jasmine
Article No. 565.71.630



Finish: Rock Grey
Article No. 565.71.530



Finish: Coffee
Article No. 565.71.830



Finish: Tartufo
Article No. 565.71.030

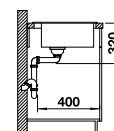
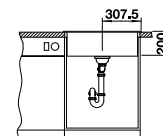
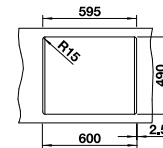
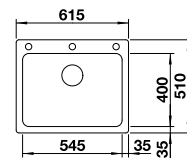

Overall Size(mm/inch): 615x510mmx 220mm / 24.21"x20.08"x7.87"

Bowl Size(mm/inch): 545x400mm / 21.46" x 15.74"

Scope of supply: waste fitting with space-saving pipe, two 3 1/2" basket strainers

Optional accessories



Outlet Cover CapFlow
565.69.890



Odour Trap
565.69.039

Faucets That Redefine Ergonomics



Sleek, clean lines or sinuous shapes, we have the competence in faucets to match the elegance of your sink centre.

Equip your sink centre with a faucet which matches the design of your kitchen. BLANCO faucets incorporate a high quality mechanism, are equipped with a wide variety of additional functions and make all your chores much easier – from washing salad to cleaning pans. Make the most of the high degree of creative freedom they offer and combine the materials and colours of the SILGRANIT™-look or ceramic-look taps with the matching sinks.

**FEATURES:**

- Our faucets are extensively tested and certified, they thus provide maximum safety in terms of health and hygiene
- Created with certified quality materials; all water conducting parts of the faucet have been tested
- Our faucets provide longevity in use thanks to the long- life ceramic disc cartridges which provide for a precise adjustment of the water amount and temperature

Put your trust in BLANCO mixer taps.
Quality for the sake of your health.



Avoid risks to your health.

Untested taps can significantly exceed the maximum permissible value for substances which endanger health. BLANCO taps are extensively tested and certified. They thus provide maximum safety in terms of health and hygiene.

Clean water is our contribution to your health.

BLANCO proves its high sense of responsibility towards people and the environment in many ways, not only by exclusively using certified quality materials in all water-conducting parts of BLANCO taps, but also by continuously monitoring them by means of voluntary tests.

The advantages for you:

- a good feeling every day about the hygiene and health protection for the whole family
- confirmed safety when buying taps
- durable products with high quality

BLANCO taps: seal of approval for safety and hygiene.

Blanco has the technology and hygiene of its taps voluntarily tested according to the stipulations of the German drinking water regulation and certified by the DVGW Cert GmbH (Certification body of the German Scientific and Technical Association for Gas and Water e.V.).

With this certification BLANCO taps provide one of the highest qualities currently available in the Indian market.

The voluntary certification by the DVGW is BLANCO's documentary proof that requirements for the protection of drinking water are being observed.

Before the certification takes place, the technology and hygiene of a range of taps are subjected to a large number of individual tests by various, independent institutes.

The following criteria are an essential part of these tests:

- safeness of the materials used (all materials coming into contact with water are tested for hygienic properties and constituents which can present a health hazard.)

- durability in hot-cold permanent use
- flow rate
- intensity of water noise



The patented Neoperl cascade reduces lime-scale and provides an even flow of water.



The integrated check valve keeps used water away when the spray is in use.



Elastic silicone nubs keep the spray free of limescale, and are easily cleaned just by rubbing with a finger.

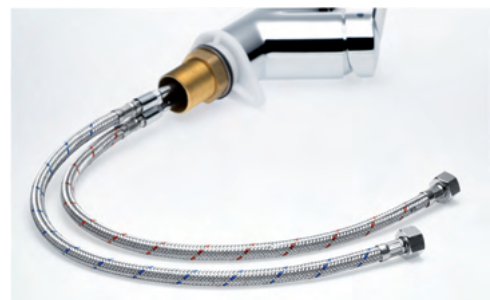

Because they are so long, the flexible connection hoses are ideal even for difficult conditions.



Long-life ceramic disc cartridges provide for a precise adjustment of water amount and temperature.



BLANCO CARENA-S Vario



BLANCO CARENA-S Vario

Metallic surface and SILGRANIT™ Look dual finish Bold design with a special functionality

- Classic modern premium mixer tap
- Covered pull-out two-spray hose with changeover function
- High arched outlet for easy filling of pots and vases
- High positioned, ergonomic control lever
- Bi-Color - the perfect colour match for SILGRANIT™ sink units and bowls



BLANCO CARENA-S

Specification



Finish: Chrome
Article No. 569.03.260



Finish: Alu Metallic
Article No. 569.03.960



Finish: Anthracite
Article No. 569.03.360



Finish: Coffee
Article No. 569.03.860



Finish: Jasmine
Article No. 569.03.660



Finish: Rock Grey
Article No. 569.03.560



Finish: Tartufo
Article No. 569.03.060



Finish: White
Article No. 569.03.760

- 190° swivel spout for greater reach
- Ø 35 mm tap hole required
- With ceramic disk cartridge
- Textile covered spray hose
- Covered spray hose with change-over button on the back
- Flexible connector pipes, 450 mm long and 3/8" nut for particularly easy installation
- Patented jet regulator for markedly reduced scaling
- Stabilisation plate to increase the stability of the tap when fitted in stainless steel sinks
- With non-return valve and thus guaranteed against reflux in accordance with EN 1717
- LGA approved
- Planned for DVGW certificate

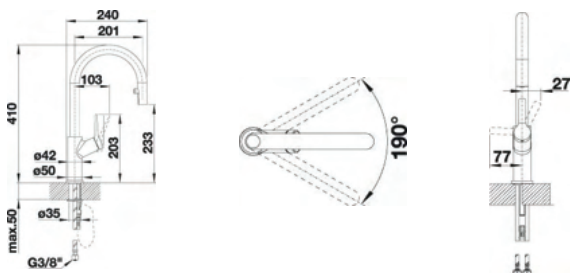

BLANCO TIVO-S



**Metallic surface and SILGRANIT™ Look dual finish
Comfort in best shape**

- High spout for easier work at the sink
- Extendable spray with switching function
- Particularly adapted for modern sinks
- Colour version in perfect coordination with coloured SILGRANIT™ sinks and bowls



BLANCOTIVO-S

Specification



Finish: Chrome
Article No. 569.02.210



Finish: Alu Metallic
Article No. 569.02.910



Finish: Anthracite
Article No. 569.02.310



Finish: Coffee
Article No. 569.02.810



Finish: Jasmine
Article No. 569.02.610



Finish: Rock grey
Article No. 569.02.516



Finish: Tartufo
Article No. 569.02.010



Finish: White
Article No. 569.02.710

- Spout can be swivelled by 120°
- Ø 35 mm tap hole required
- With ceramic disk cartridge
- Metal-sheathed spray hose
- Flexible connection pipes with a length of 450 mm and 3/8" nut for particularly easy and secure installation
- Patented jet regulator for markedly reduced scaling
- Stabilisation plate to increase the stability of the tap when fitted in stainless steel sinks
- With non-return valve and thus guaranteed against reflux in accordance with EN 1717
- LGA approved
- DVGW approved

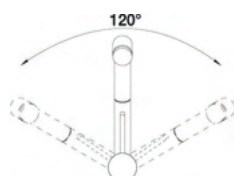
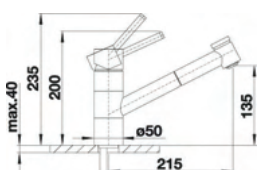

BLANCO MIDA-S



Metallic surface and SILGRANIT™. Look Stylish form Gently rounded spout on a slender body

- For the easy filling of tall pots and vases
- Especially suitable for compact sinks
- Enlarged working radius thanks to the 360° swivel spout
- Pull-down spray hose for added reach
- Colour version in perfect coordination with coloured SILGRANIT™ sinks and bowls



BLANCOMIDA-S

Specification



Finish: Chrome
Article No. 569.10.200



Finish: Anthracite
Article No. 569.10.300



Finish: Alu Metallic
Article No. 569.10.900



Finish: Coffee
Article No. 569.10.800



Finish: Jasmine
Article No. 569.10.600



Finish: White
Article No. 569.10.700

- 360° swivel spout for greater reach
- Ø 35 mm tap hole required
- With ceramic disk cartridge
- Flexible connector pipes, 350 mm long and 3/8" nut for particularly easy installation
- Nylon-sheathed spray hose
- Patented jet regulator for markedly reduced scaling
- Stabilisation plate to increase the stability of the tap when fitted in stainless steel sinks
- With non-return valve and thus guaranteed against reflux in accordance with EN 1717
- LGA approved

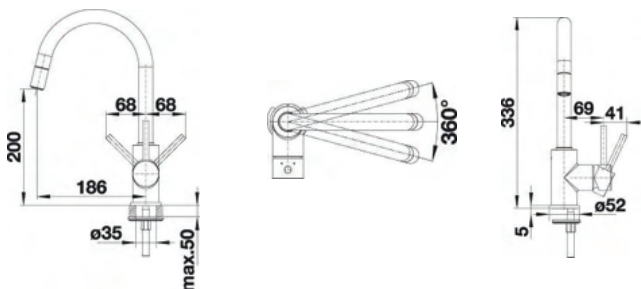

BLANCO LINUS-S - SILGRANIT™ -Look



Practical in form and function

- High arc spout for easy filling of pans and vases
- High-quality metal design of the spray (pull out)
- Lever can be positioned on the left, the right or in the centre
- Design and colour of tap and coloured sink are a perfect match (SILGRANIT-look)
- Extendable spray (pull out)
- Water flow rate of 6L/minute at 3 bar dynamic water pressure



BLANCOLINUS-S	Specification	BLANCOLINUS-S	Specification
---------------	---------------	---------------	---------------



Finish: Anthracite
Article No. 565.68.350



Finish: Alu Metallic
Article No. 565.68.950

- Swivel spout
- 35 mm Ø tap hole required
- With ceramic seals
- Metal-sheathed spray hose
- Flexible 450 mm connector hoses and 3/8" nut for particularly easy and secure installation
- Patented jet regulator /cascade for markedly reduced scaling
- Stabilising plate to increase the stability of the tap when fitted in stainless steel sinks
- Equipped with non-return valve as standard and hence intrinsically safe against back flow in accordance with EN 1717
- LGA approved
- DVGW approved



Finish: White
Article No. 565.68.750



Finish: Jasmine
Article No. 565.68.650



Finish: Chrome
Article No. 565.68.250



Finish: Rock Grey
Article No. 565.68.550



Finish: Coffee
Article No. 565.68.450



Finish: Tartufo
Article No. 565.68.050

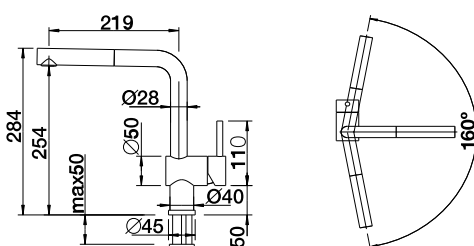

BLANCO MILI



Metallic surface and SILGRANIT™-Look Comfort with contours

- Slender body with a J-shaped spout
- For the easy filling of tall pots and vases
- Enlarged working radius thanks to the 360° swivel spout
- Design and colour of tap and SILGRANIT™ sink are a perfect match



BLANCOMILI

Specification



Finish: Chrome
Article No. 569.09.260



Finish: Anthracite
Article No. 569.09.360



Finish: Coffee
Article No. 569.09.870



Finish: Jasmine
Article No. 569.09.660



Finish: White
Article No. 569.09.760

- Single-lever mixer tap
- 360° swivel spout for greater reach
- Ø 35 mm tap hole required
- With ceramic disk cartridge
- Flexible connector pipes, 350 mm long and 3/8" nut for particularly easy installation

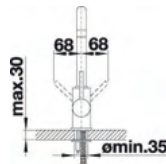
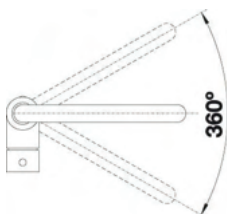
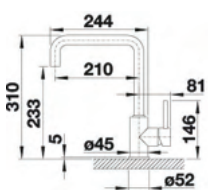

BLANCO MILA-S



Classic and clear

- Slender body with a straight-lined spout
- With extendable spray (pull out)
- For the easy filling of tall pots and vases
- Enlarged working radius thanks to the 360° swivel spout



BLANCOMILA-S

Specification



Finish: Chrome
Article No. 569.06.210

- Single-lever mixer tap
- Spout can be swivelled by 360°
- Ø 35 mm tap hole required
- With ceramic disk cartridge
- Nylon-sheathed spray hose
- Flexible connector pipes, 350 mm long and 3/8" nut for particularly easy installation

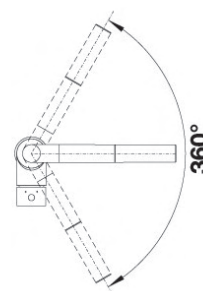
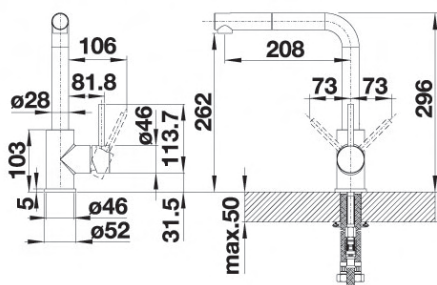

BLANCO MIDA



- High spout for easy filling of pans and vases
- Enlarged radius: spout revolvable 360°



BLANCOMIDA

Specification



Finish: Chrome
Article No. 569.04.230

- Single-lever mixer tap
- Spout can be swivelled by 360°
- Ø 35 mm tap hole required
- With ceramic disk cartridge
- Flexible connector pipes, 350 mm long and 3/8" nut for particularly easy installation
- LGA approved

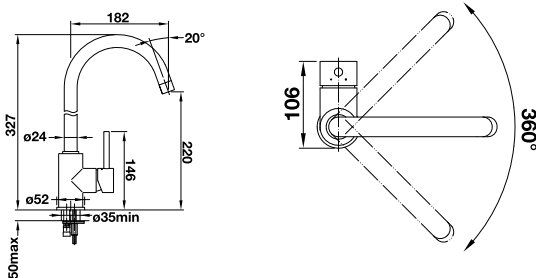

BLANCO DARAS-S



- With extendable spray head
- Particularly suitable for small sinks



BLANCODARAS-S

Specification



Finish: Chrome
Article No. 569.06.260

- Single-lever mixer tap
- Spout can be swivelled by 80° (chrome version) or by 120° (SILGRANIT™-version)
- Ø 35 mm tap hole required
- With ceramic disk cartridge
- Flexible connector pipes, 350 mm long and 3/8" nut for particularly easy and safe installation
- Nylon-sheathed spray hose
- Serially with non-return valve and thus guaranteed against reflux in accordance with EN 1717
- LGA approved

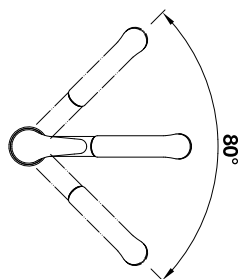
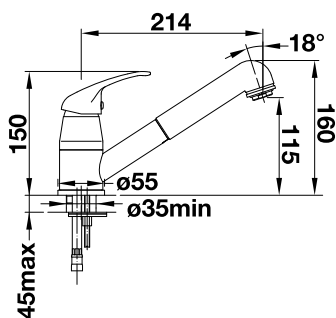

BLANCO DARAS



- Particularly suitable for small sinks
- Enlarged working radius due to 360° swivelling spout

BLANCODARAS

Specification



Finish: Chrome
Article No. 569.05.250

- Single-lever mixer tap
- Spout can be swivelled by 360°
- Ø 35 mm tap hole required
- With ceramic disk cartridge
- Flexible connector pipes, 350 mm long and 3/8" nut for particularly easy installation
- LGA approved

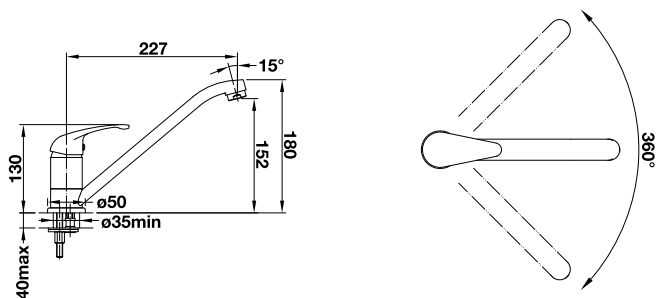

Installation examples - undermount, flush-mount and flush undermounted installation

Undermounted

All BLANCO inset sinks can also be installed from below in non-hygroscopic worktops made of natural stone or composite.

The sink is tightened against the worktop below the cut-out by means of special retaining brackets. This requires the mounting of a special dowel on the underside of the worktop.

The rim of the sink and the lower edge of the worktop are sealed with sealant.

Please note:

The control elements' accessibility and the ease of cleaning can be affected by undermount installation.

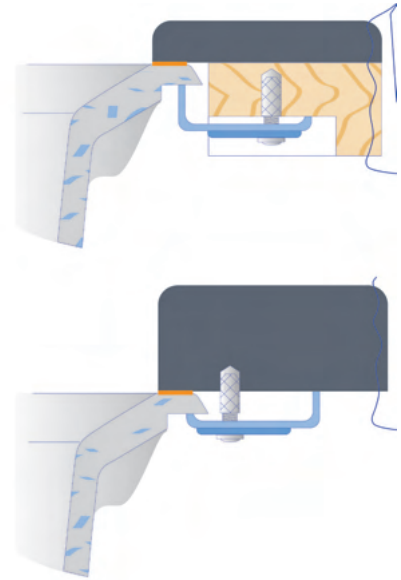

Flush mounted

The flush mounting procedure involves inserting the sink from above. Only special models with a specially designed rim are suitable for this.

For laminated worktops, the sink is drawn into a supporting profile which is either screwed, bonded or integrally cast into the worktops cut-out.

Where the worktops are made of granite or composite, the sink is drawn onto a recess milled into the work surface.

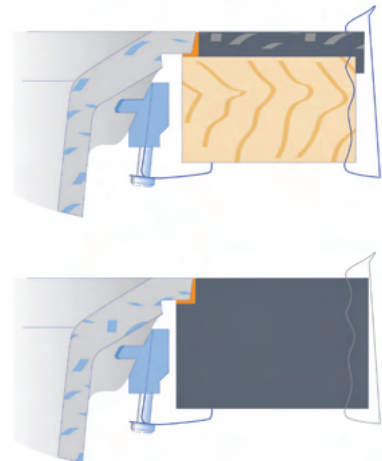
In both cases, the sink lies in an all-round bed of sealant to ensure durable, secure bonding of sink and surface and prevent moisture seeping in.

Flush undermounted

The procedure for flush undermounting involves inserting the sink from below. All BLANCO sinks are suitable for this. For laminated worktops, the substrate around the cut-out is completely removed by milling from below down to the top layer of the worktop. The rim of the sink is bonded against the laminate layer and the sink is permanently bonded with the worktop from below by filling with a cast resin.

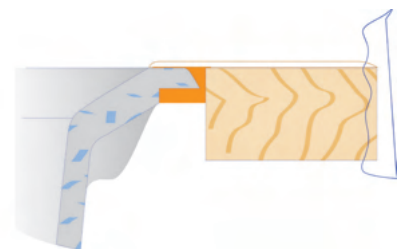



CONTENTS

PAGE 54-81

64	FLAMBE ROUND
66	SOLO
68	CENTURY
70	BE PURE
72	SLIM
74	SWING
76	TROPIC
78	TRENTA
80	PLUMA





This articulated product range, carries modern single lever mixers in a young and functional design along with the most classic fashion line. Made in Italy, these taps are the result of long-term investigation and experience thereby ensuring quality and safety for the customer.





ITALIAN FASHION REFORMS YOUR KITCHEN

Kitchen Mixers from Italy that spell class and elegance with uncompromising functionality.

We bring to you our exclusive range of kitchen faucets from Italy. Backed by more than 40 years of investigation and experience, this range is a synonym of quality and safety for you, our customer. Available in classic Italian designs or modern contemporary lines, you can't miss your favourite pick from this range.

Features:



Long Operational Life:

These taps are completely manufactured in Italy and are the result of long-term investigation and experience, synonym with quality and safety for the customer. With this body of experience and the 10 years warranty provided by Häfele, these taps guarantee a long operational life.



Perfect Water Flow:

Häfele's Italian Kitchen Taps have a flawless stream quality even under difficult flow conditions



Quiet Operation: These Kitchen Taps have a very low operational noise level thus accounting for maximum ease and comfort to the customer



Vandal Resistant Aerator:

The Italian Kitchen Taps have vandal resistant aerators which cannot be removed without using a special key, supplied with the product



Water Sense Technology:

These Taps are integrated with a Water Sense Technology which helps save 20% more water than similar products in the market



Smart Lime Cleaning:

The Italian Kitchen Taps by Häfele have an Anti-Lime pure water outlet design for their aerator which reduces the possibility of lime formation & increases the maximum lifespan of the faucet aerator

Technology

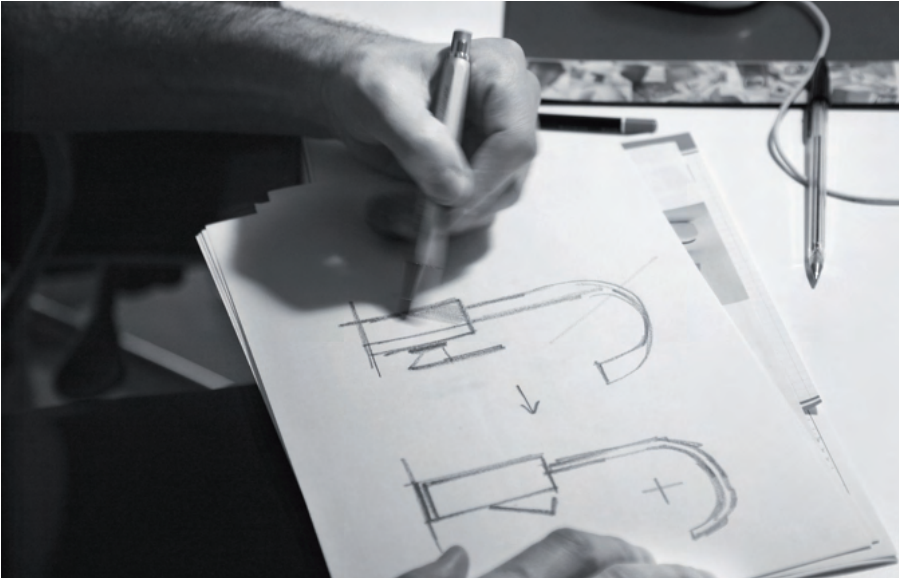
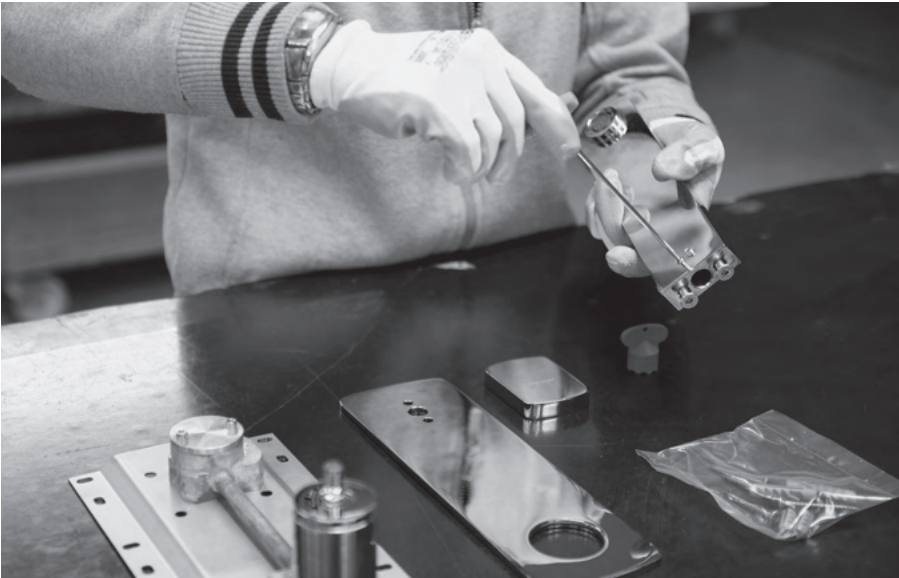

Technology



Think about the future... Today

think
.....
green

How to save water?

Consumptions can be reduced and it's easier than what you think
Avoid wasting.

For example, use full load washing machine and dishwasher, water the plants at evening when temperature is lower, do not leave taps open unless necessary (letting the water run as you brush your teeth)...

Use low water consumption systems.

Flow reducers, thermostatic taps, aerated taps and low consumption appliances together with a water use attentive and rational, guarantee remarkable **drinking water saving up to 20-30%**.



FLAMBE ROUND

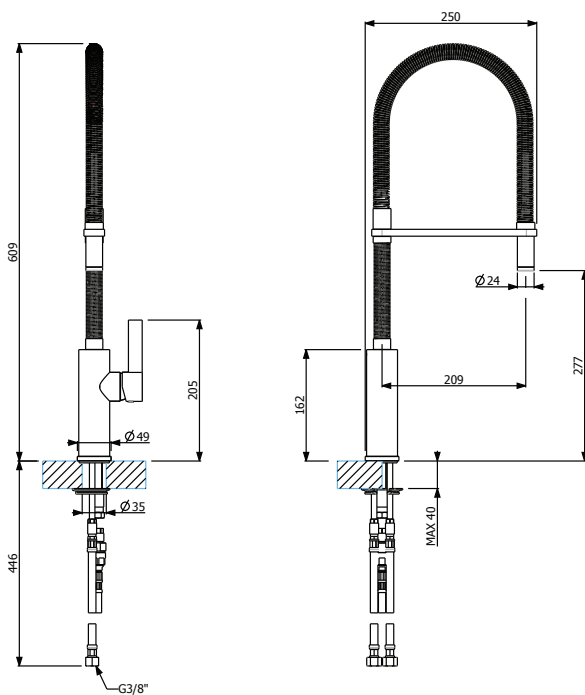

FLAMBE ROUND - Single lever kitchen mixer with turning spout shower

Chrome: 566.22.210

Brushed Chrome: 566.24.280

C shaped removable spout made of SS

Soft touch spray surface

Rotating spout: 360°

Hole diameter: 35mm

Height of mixer: 609mm

Height up to aerator: 277mm

Flow Rate (at 3 bar water pressure) : 7.8 l/min





SOLO

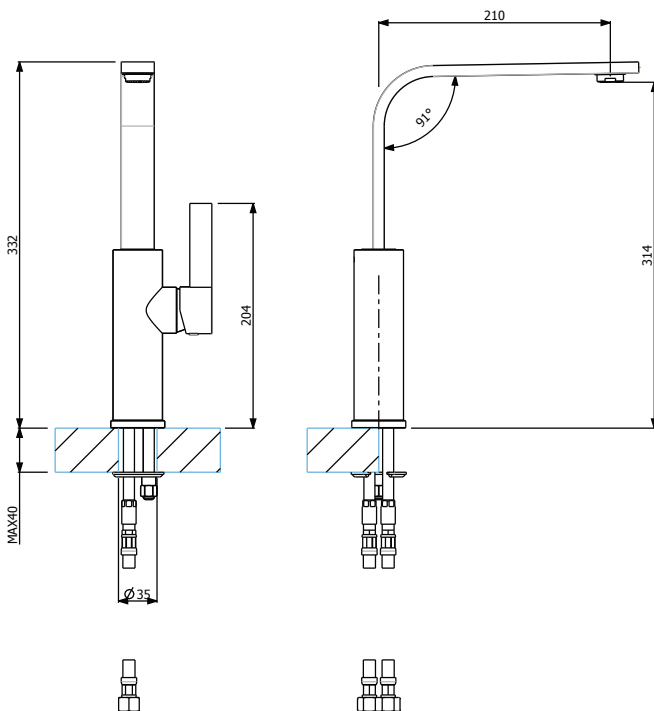

SOLO - Single lever Kitchen mixer

Chrome: 566.23.270

Brushed Chrome: 566.24.240

Rotating spout: 360°

Hole diameter: 35mm

Height of mixer: 332mm

Height up to aerator: 315mm

Flow Rate (at 3 bar water pressure) : 9.4 l/min





CENTURY

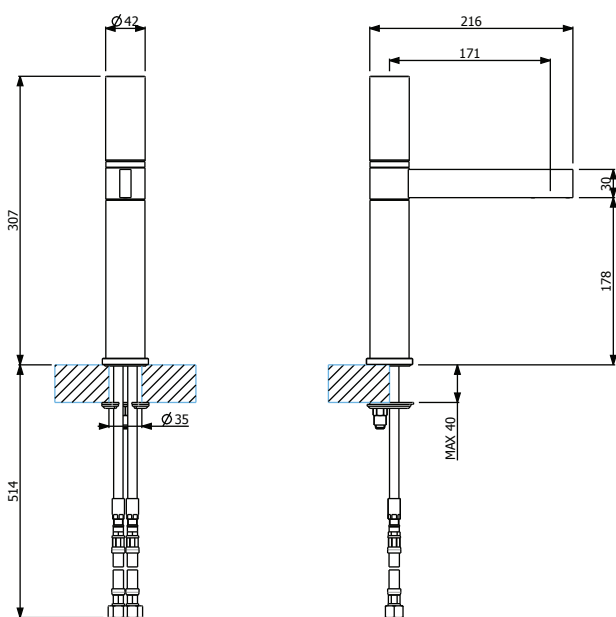

CENTURY - Single lever Kitchen mixer

Chrome: 566.22.230

Brushed Chrome: 566.24.290

Soft touch handle surface

Rotating spout: 360°

Hole diameter: 35mm

Height of mixer: 307mm

Height up to aerator: 168mm

Flow Rate (at 3 bar water pressure) : 8 l/min





BE PURE

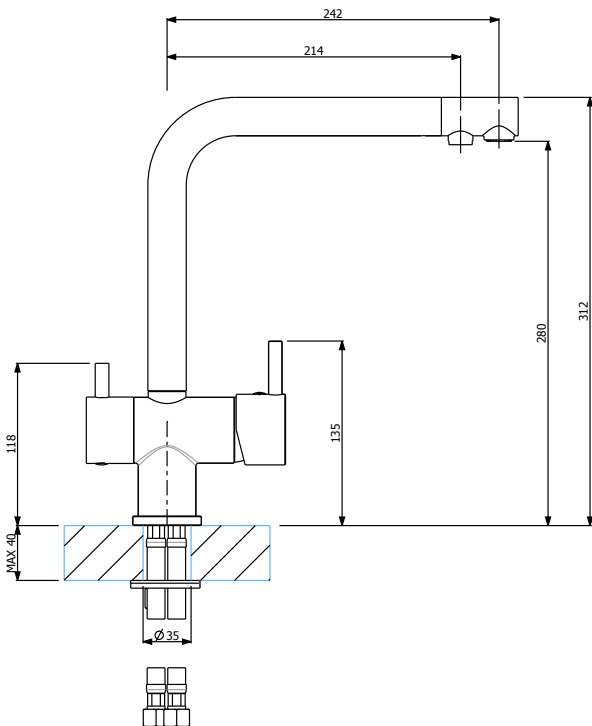

BE PURE - Single lever kitchen mixer with separate outlet for drinking water

Chrome: 566.22.290

Brushed Chrome: 566.24.220

Anthracite: 566.28.340

Alumetallic: 566.28.940

Rock Grey: 566.28.540

Coffee: 566.28.840

Copper pipe for healthy and pure drinking water

Ceramic valve for pure water

Rotating spout : 360°

Hole diameter : 35mm

Height of mixer : 312mm

Height up to aerator : 280mm

Flow Rate (at 3 bar water pressure) : 9.8 l/min



SLIM

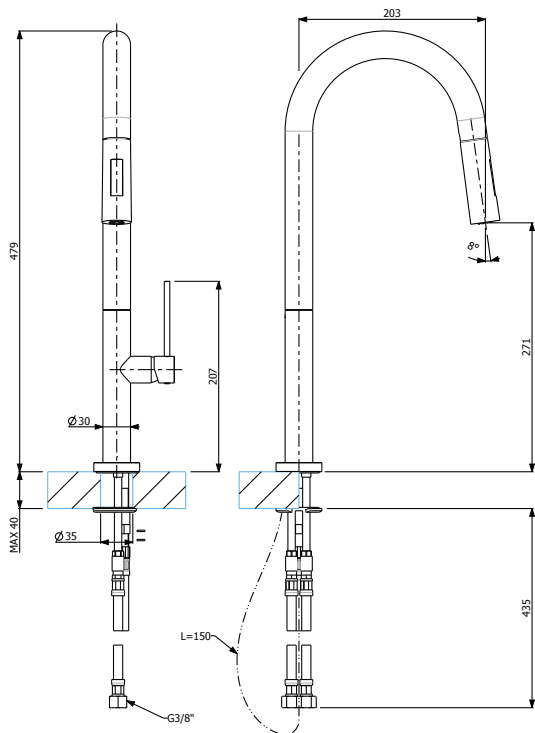

SLIM - Single lever kitchen mixer with pull-out shower double jet

Chrome: 566.23.280

Brushed Chrome: 566.24.250

1500 mm shower hose for extendable spray
(dual flow jet)

Rotating spout: 360°

Hole diameter: 35mm

Height of mixer: 479mm

Height up to aerator: 271mm

Flow Rate (at 3 bar water pressure) : 6.6 l/min





SWING

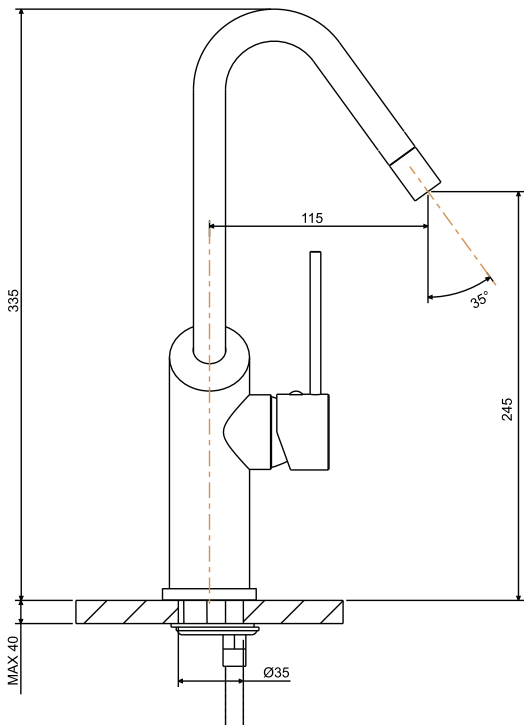

SWING - Single lever kitchen mixer

Chrome: 566.23.290

Brushed Chrome: 566.24.260

Rotating spout: 360°

Hole diameter: 35mm

Height of mixer: 335mm

Height up to aerator: 245mm

Flow Rate (at 3 bar water pressure) : 9.7 l/min





TROPIC

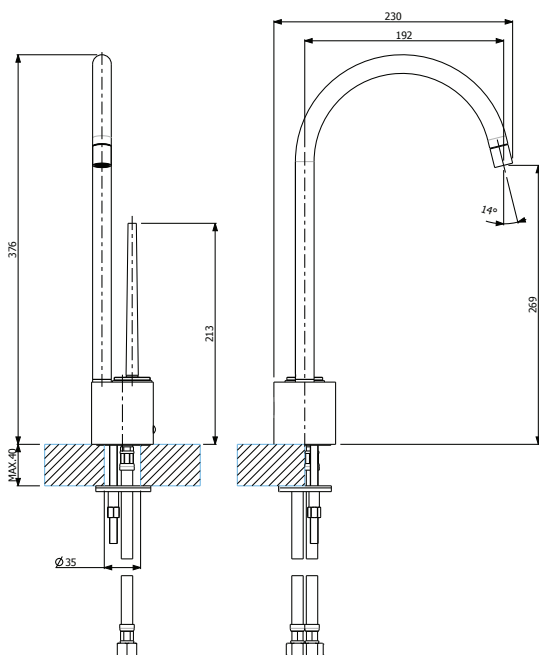

TROPIC - Single lever Kitchen mixer

Chrome: 566.22.250

Joystick movement cartridge

Rotating spout: 360°

Height of mixer: 376mm

Height up to aerator: 269mm

Flow Rate (at 3 bar water pressure) : 9.9 l/min





TRENTA

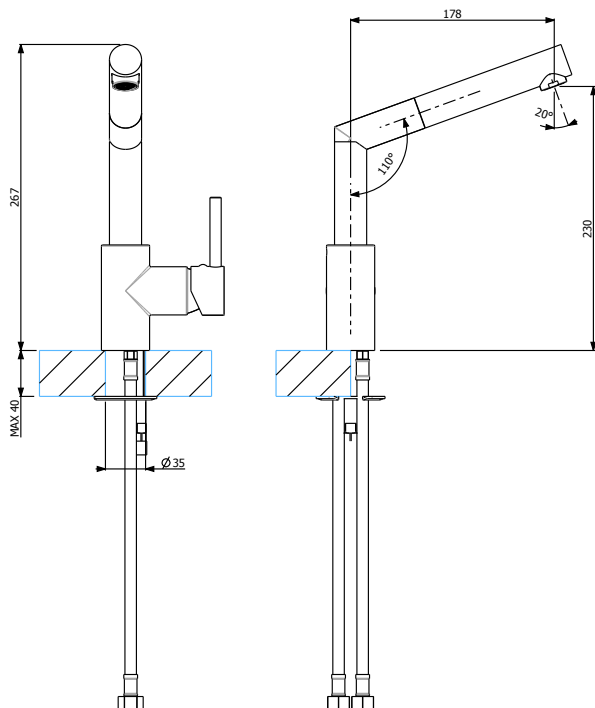

TRENTA - Single lever kitchen mixer with pull-out shower

Chrome: 566.21.200

Brushed Chrome: 566.21.240

1500 mm shower hose for extendable spray

Rotating spout: 360°

Hole diameter: 35mm

Height of mixer: 267mm

Height up to aerator: 230mm

Flow Rate (at 3 bar water pressure) : 11.7 l/min





PLUMA

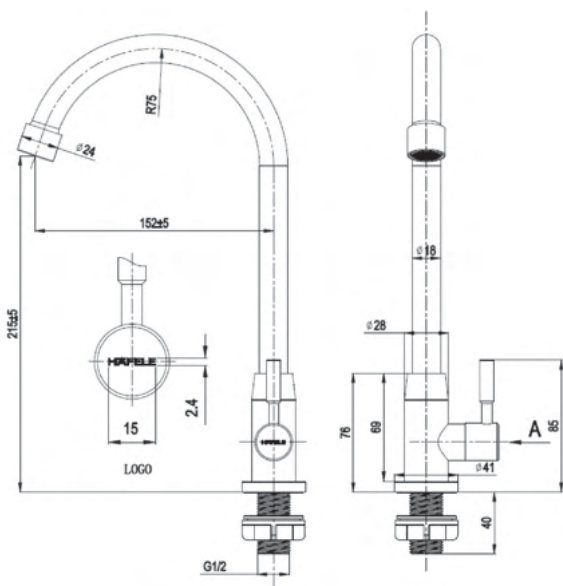

PLUMA - Pluma Deck Mounted Cold Faucet

Chrome: 570.85.031

Material: Stainless Steel 304

Finish: Stainless Steel Brushed

Dimension: 239 (H) × 152 (D) × 18 (Ø) mm

Flow Rate: 7 litres/ min at 3 Bar Pressure

Warranty: 10 years* (residential); 5 years* (commercial)



Abrasion/
Scratch
Resistant



Durable



Corrosion
Resistant



Stain
Resistant



Lead
Free



10
Years
Warranty
* T & C
Apply



CONTENTS

Stainless Steel Kitchen
Sinks & Taps

PAGE **82-113**

Blanco SteelArt

- 90 BLANCO FLOW
45 S-IF / 5 S-IF
- 91 BLANCO FLOW
XL 6 S-IF
- 92 BLANCO CLARONLINE -Undermount
- 93 BLANCO CLARON- IF/N
without tap ledge
- 94 BLANCO CLARON- IF/A
with tap Ledge
- 95 BLANCO ZEROX Undermount
- 96 Installation Methods

ARGENTO Handmade Sinks

- 103 TOPAZ
- 105 EMERALD
- 106 SAPPHIRE
- 107 RUBY

SPLASH Punch Bowl Sinks & Taps

- 110 MONETA
- 112 CAMELIA
- 113 CORAL





STEELART

Experience something special

The moment you see them, some things radiate an aura that you can't quite describe. Although they clearly outshine everything around them, they do so in an understated manner. You can sense the hours of craftsmanship and every thought invested in their creation. All stainless steel sinks in the STEELART high tech manufacture are produced in small-scale series with loving attention to detail, ensuring that all products meet the highest standards of quality and exclusive exceptional design.

We invite you to discover and experience the world of SteelArt - The minimalist, beautifully crafted range of our hand-made stainless steel bowls and sinks that adds very special accents in your kitchen.



Excellent variety





SteelArt offers an unimagined choice of bowls and sinks in perfectly matched designs. Be it the eye-catching bowls with strict right-angled geometry, or the elegant sinks with the minimally rounded corners. SteelArt blends stylishly with any kitchen environment. Discover the highlights in our exclusive stainless steel collection.

This product catalogue takes you through the exclusive range of bowls and sinks, whether in the flushmount look with a 1 mm rim or for undermount installation.

The Material – Stainless Steel

Stainless steel is often called the preferred material of discerning product designers and kitchen planners. Its unique material properties make this elegant material the first choice for the highest standards in high-end and exclusive designs. But what exactly is behind this all-rounder?

We have compiled the most relevant information for you in this piece:

- 
Recyclable: Stainless steel is a natural, environmentally friendly material that is 100% recyclable. This means that all items made of stainless steel can go back into the production of new materials at the end of their life cycle.
- 
Corrosion-resistant: BLANCO uses the highest stainless steel quality that consists mainly of iron (72%), chrome (18%) and nickel (10%). This composition makes it resistant to corrosion.
- 
Anti-Rusting: Stainless steel does not rust. Any rust marks that appear on the surface are from other sources. This rust is an oxidation of deposited foreign materials.
- 
Self-renewing: Stainless steel constantly renews itself. In fact, it is said to have a self-healing surface, also called the passive layer. If the surface is damaged, oxygen helps it to renew itself. This is always of benefit to the material in daily use.
- 
Durable: Thanks to the zoning of the passive layer, there is no need for corrosion protection. As a consequence, stainless steel retains its value and brilliance for decades.

The Finish - Stainless steel satin polish

Polished stainless steel delights with its glossy look. The classically timeless surface in satin polish blends perfectly with an aesthetic design. The material is made from the purest stainless steel, and differs from other stainless steel surfaces in its linear brushed finish. The very fine polish on the surface leaves the stainless steel feeling particularly smooth.

Cleaning And Care (Stainless Steel Satin Polish / Satin Matt).

1. Deep clean (satin polish finishes only):

We recommend cleaning and maintaining the surface with BLANCO POLISH every 1-2 weeks.

BLANCO POLISH makes daily cleaning much easier, and removes heavy dirt and limescale deposits. It seals the surface, giving it a self-cleaning effect, and also removes minor signs of use.

BLANCO POLISH:

- Removes scratches
- Removes rust and stains
- Water just rolls off the surface after use
- Prevents finger prints and other marks and dirt from settling
- Leaves a silky-matt shine

BLANCO STEELART care set:

- 1 x BLANCO microfibre cloth
- 1 x BLANCO POLISH
- 1 x Vileda sponge, non-scratch

2. Daily cleaning: All that is required for daily cleaning is a soft sponge or damp microfibre cloth and normal commercial cleaning detergent. You can also use vinegar or lemon cleaner to remove limescale.

BLANCO household tip: Clean with vinegar water (20% vinegar, 80% water) or with lemon juice diluted in water.



Advantages of Having BLANCO STEELART in your Kitchen

- **Optimum space utilization for more comfort:**
BLANCO offers solutions for any size of sink cabinet. A cabinet width of 60 cm is ideal for sinks with a main and additional bowl, but there are also numerous models for other spatial and planning situations.
- **Ergonomics and functionality make everything easier:**
The bowls and accessories are designed to match each other perfectly and make work-sequences flow smoothly.
- **Comfort in a system:**
It is the perfect interplay between sink, mixer tap, waste system and accessories that creates a functional sinkcentre.
- **Material and colour add highlights:**
The right combination of sink and mixer tap creates an ambience that matches any home living style.
- **Mixer taps by BLANCO:**
BLANCO offers a wide selection of designs of high functionality. Certified in accordance with the strict quality criteria of independent test institutes, they meet the highest requirements for safety and hygiene.
- **Cleaning made easy:**
The surfaces of sinks and mixer taps are wonderfully easy to clean. Special materials help to repel dirt and water.



BLANCO STEELART Exclusivity in stainless steel



The exclusive BLANCO FLOW inset sink is in a clear, balanced design that instantly soothes the eye of the observer.



The innovative stainless steel BLANCO Durinox® surface appeals for its particular hardness that makes it particularly resilient to scratches.

Award-winning form and function

Renowned awards confirm BLANCO's design competence



reddot award 2015
winner



German
Design Award
WINNER 2014



interior
innovation
award
2015
Winner



DESIGN
AWARD
2015



reddot award 2014
winner



German
Design Award
NOMINEE 2014



interior
innovation
award
2014
Winner



product
design award



reddot design award
best of the best 2013



German
Design Award
SPECIAL
MENTION 2015



interior
innovation
award
2014
Selection



2014



Focus Open 2014
Special Mention



German
Design Award
NOMINEE 2013



interior
innovation
award
2013
Winner



product
design award



Focus Open 2013
Special Mention



M
GOLD
AWARD
Surface/
Technology



interior
innovation
award
2013
Best of Best



2013

KB CULTURE AWARDS 2013

BLANCO FLOW 45 S-IF / 5 S-IF



The flowing connection

- Inset sink with flowing connections between draining boards and the main bowl
- Symmetrical design thanks to central main bowl with draining areas on both sides
- IF flat rim for an elegant look and flush installation



FLOW 5 S-IF

Specification

50 cm cabinet size



Finish: Satin Polish
Article No. *565.67.460

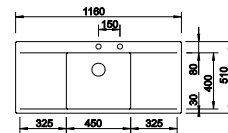

Overall Size(mm/inch): 1160 X 510 X 190 / (46" X 22" X 7.6")

Bowl Size(mm/inch): 450 X 400 X 190 / (18" X 16" X 7.6")

Scope of supply: waste and overflow fitting with space saving pipe, 3 ½" basket strainer with chrome-plated round standard pop-up remote control*, fixing element set (sealing not included)

BLANCO FLOW XL 6 S-IF



The connection that flows

- Inset sink with flowing connections between drainer and bowl
- Large hand-made XL-single bowl
- Harmonious proportions of drainer and bowl
- IF flat rim for an elegant look and flush installation
- Suitable for almost any planning situation
- Optional tap ledges also with individually configurable tapholes



FLOW XL 6 S-IF

Specification

60 cm cabinet size



Finish: Satin Polish
Article No. *565.65.840

Overall Size(mm/inch): 1060 X 510 X 190 / (42.4" X 22" X 7.6")

Bowl Size(mm/inch): 425 X 400 X 190 / (17" X 16" X 7.6")

Scope of supply: manual waste and overflow fitting with space-saving pipe, 3 1/2" basket strainer, BLANCO CapFlow™ outlet cover, fixing kit (seal not included)

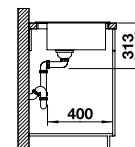
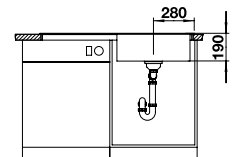
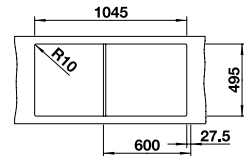
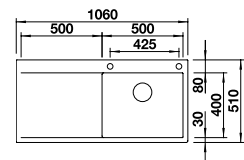

*Special Order

BLANCO CLARONLINE Undermount



Highlight of clear design language – the programme of inset sinks in an elegant-pure design

- A revolution in form and technology: seamless transitions of radii into straight lines create unrivalled contours
- Elegant corner radii of only 10 mm
- Wide product programme of exclusive, handmade inset sinks and sink units
- IF flat rim

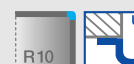

CLARON 400 U

Specification

45 cm cabinet size



Finish: Satin Polish
Article No. *565.65.860

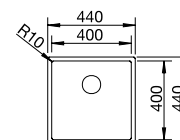

Overall Size(mm/inch): 440 X 440 X 190 / (17.6" X 17.6" X 7.6")

Bowl Size(mm/inch): 400 X 400 X 190 / (16" X 16" X 7.6")

Scope of supply: manually operated waste and overflow fitting* with space saving pipe, 3 ½" basket strainer, fixing element set (sealing not included)

CLARON 550 U

Specification

60 cm cabinet size



Finish: Satin Polish
Article No. *565.65.870

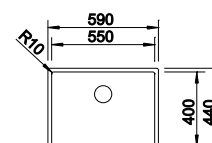

Overall Size(mm/inch): 590 X 440 X 190 / (23.6" X 17.6" x 7.6")

Bowl Size(mm/inch): 550 X 400 X 190 / (22" X 16" X 7.6")

Scope of supply: manually operated waste and overflow fitting* with space saving pipe, 3 ½" basket strainer, fixing element set (sealing not included)

CLARON 700 U

Specification

80 cm cabinet size



Finish: Satin Polish
Article No. *565.65.880

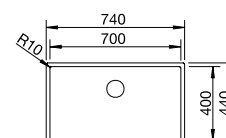

Overall Size(mm/inch): 740 X 440 X 190 / (29.6" X 17.6" X 7.6")

Bowl Size(mm/inch): 700 X 400 X 190 / (28" X 16" X 7.6")

Scope of supply: manually operated waste and overflow fitting* with space saving pipe, 3 ½" basket strainer, fixing element set (sealing not included)

*Special Order

BLANCO CLARON-IF/N without tap ledge



Perfect in design and function

- Concise 10 mm radius for more design - without sacrificing functional advantages
- BLANCO CLARON in elegant-pure design with no visible base pattern
- Optimum utilisation of the bowl capacity thanks to extra deep bowls and smallest possible radii
- Wide product programme makes it possible to have a high number of individual combinations



CLARON 400-IF/N

Specification

45 cm cabinet size



Finish: Satin Polish
Article No. *565.67.260

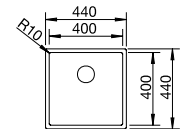

Overall Size(mm/inch): 440 X 440 X 190 / (17.6" X 17.6" X 7.6")

Bowl Size(mm/inch): 400 X 400 X 190 / (16" X 16" X 7.6")

Scope of supply: manually operated waste and overflow fitting* with space saving pipe, 3 1/2" basket strainer, fixing element set (sealing not included)

CLARON 550-IF/N

Specification

60 cm cabinet size



Finish: Satin Polish
Article No. *565.65.890

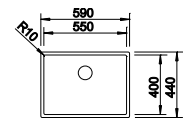

Overall Size(mm/inch): 590 X 440 X 190 / (23.6" X 17.6" X 7.6")

Bowl Size(mm/inch): 550 X 400 X 190 / (22" X 16" X 7.6")

Scope of supply: manually operated waste and overflow fitting* with space saving pipe, 3 1/2" basket strainer, fixing element set (sealing not included)

CLARON 700-IF/N

Specification

80 cm cabinet size



Finish: Satin Polish
Article No. *565.67.680

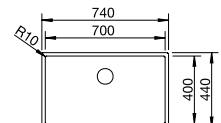

Overall Size(mm/inch): 740 X 440 X 190 / (29.6" X 17.6" X 7.6")

Bowl Size(mm/inch): 700 X 400 X 190 / (28" X 16" X 7.6")

Scope of supply: manually operated waste and overflow fitting* with space saving pipe, 3 1/2" basket strainer, fixing element set (sealing not included)

*Special Order

BLANCO CLARONLINE-IF/A with tap ledge



Highlight of clear design language – the programme of inset sinks in an elegant-pure design

- A revolution in form and technology: seamless transitions of radii into straight lines create unrivalled contours
- Elegant corner radii of only 10 mm
- Wide product programme of exclusive, handmade inset sinks and sink units
- IF flat rim



CLARON 400-IF/A

Specification

45 cm cabinet size



Finish: Satin Polish
Article No. *565.67.580

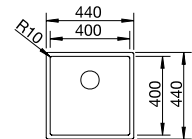

Overall Size(mm/inch): 460 X 510 X 190 / (18" X 20" X 7.6")

Bowl Size(mm/inch): 400 X 400 X 190 / (16" X 16" X 7.6")

Scope of supply: manually operated waste and overflow fitting* with space saving pipe, 3 ½" basket strainer, fixing element set (sealing not included)

CLARON 6 S-IF/A

Specification

60 cm cabinet size



Finish: Satin Polish
Article No. *565.66.201

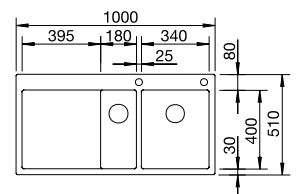

Overall Size(mm/inch): 1000 X 510 X 190 / (40" X 22" X 7.6")

Bowl Size(mm/inch): 340 X 400 X 190 / (13.6" X 16" X 7.6")

Half Bowl Size (mm/inch): 180 X 400 X 190 / (7.2" X 16" X 7.6")

Scope of supply: manually operated waste and overflow fitting* with space saving pipe, 3 ½" basket strainer, fixing element set (sealing not included)

CLARON 8S-IF/A

Specification

80 cm cabinet size



Finish: Satin Polish
Article No. *565.66.211

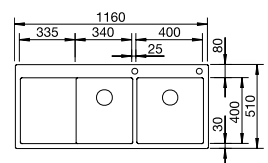

Overall Size(mm/inch): 1160 X 510 X 190 / (46" X 22" X 7.6")

Bowl Size(mm/inch): 400 X 400 X 190 / (16" X 16" X 7.6")

Half Bowl Size (mm/inch): 340 X 400 X 190 / (13.6" X 16" X 7.6")

Scope of supply: manually operated waste and overflow fitting* with space saving pipe, 3 ½" basket strainer, fixing element set (sealing not included)

*Special Order

BLANCO ZEROX Undermount



Resolute and with strength of character

- "Zero radius bowls" with the striking rectangular bowl geometry
- Comprehensive product programme makes it possible to have a multitude of individual combinations
- Best possible accessory solutions with a large number of possible combinations



XEROX Undermount

Specification

45 cm cabinet size



Finish: Satin Polish
Article No. *565.66.600

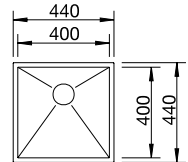

Overall Size(mm/inch):440 X 440 X 175 / (17.6" X 17.6" X 7")

Bowl Size(mm/inch): 400 X 400 X 175 / (16" X 16" X 7")

Scope of supply: manually operated waste and overflow fitting* with space saving pipe, 3 ½" basket strainer, fixing element set (sealing not included)

*Special Order

BLANCO STEELART.

Exclusive variety for all installation methods



The design-based inset programme with IF flat rim

These hand-made inset programmes are notable for the pared-down linearity of their design language and the filigree IF flat rim.

BLANCO FLOW-IF – inset and flushmount

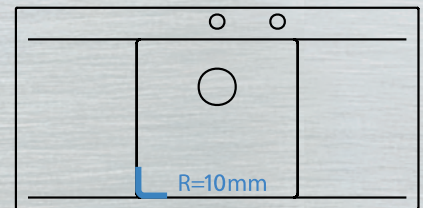

BLANCO FLOW-IF appeals for the flowing transitions in an exceptional, symmetrical design. Draining surfaces, tapered on both sides, border the central CLARON bowl.

BLANCO JARON-IF – inset and flushmount

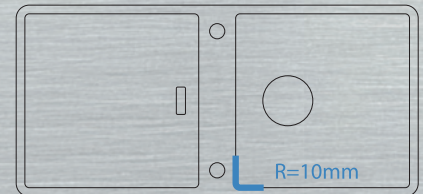
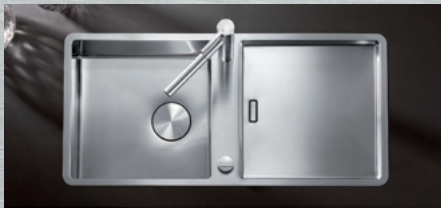

The inset sink BLANCO JARON appeals for its clear, balanced design. The two symmetrical areas with bowl and drainer are elegantly connected to each other by the tap ledge in the middle.

BLANCO CLARON-IF – inset and flushmount

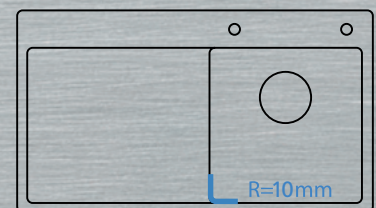

The inset family appeals for the striking corner radii of 10 mm and the IF flat rim. The innovative draining surface blends smoothly with the sink for superb contours.

BLANCO ZEROX-IF – inset and flushmount

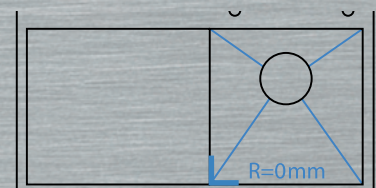

The zero radius inset family with the striking X. Visually appealing: the right-angled drainer emphasises the exclusive appearance of these hand-made designs.



Bowls and sinks for undermount, inset and flushmount installation

Two bowl lines with a consistency of design that sets new standards: BLANCO ZEROX and BLANCO CLARON in a clear design language.

BLANCO CLARON – undermount, inset and flushmount

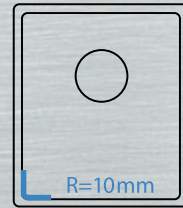

The sink programme with the striking high-tech bowl radii of just 10 mm. The small radii and special depth of the bowl provide for perfect space utilisation.

BLANCO ZEROX – undermount, inset and flushmount

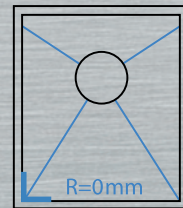

The sink programme in the striking, right-angled zero radius design. Visual feature: the base of the bowl forms an X, emphasising the linearity of the sink geometry.

Choice of installation options

Undermount



- Models:
- CLARON-U
 - ZEROX-U

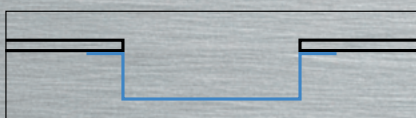

Flushmount installation



- Models:
- CLARON-IF/A*
 - CLARON-IF**
 - ZEROX-IF/A*
 - ZEROX-IF**
 - FLOW-IF

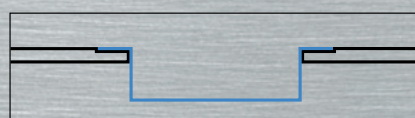

Inset:



- Models:
- CLARON-IF/A*
 - CLARON-IF**
 - ZEROX-IF/A*
 - ZEROX-IF**
 - FLOW-IF

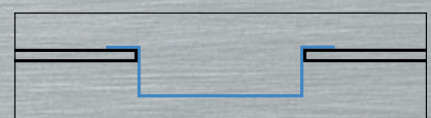

* IF/A: Models with tap ledge
 ** IF: Models w/o tap ledge

Hafele ARGENTO

The ever increasing popularity of handmade sinks is directly connected to the possibility of welding a perfectly customized sink as per the individual requirement and design preference of the customer. Hafele's range of handmade sinks from the ARGENTO series are made of high grade Stainless Steel (SS 304) and coated with an elegant satin finish – providing a durable and aesthetically stylish solution for your cleaning needs in the kitchen. Our range of ARGENTO sinks are tested to resist any external damages like chipping, cracking or peeling and the Satin coating provides additional protection from scratching and rusting. The hygienic and aseptic properties of stainless steel make the maintenance and cleaning of ARGENTO sinks virtually effortless!

Taking into account the constant exposure of a sink to dampness and moisture, our ARGENTO sinks are coated with Asphalt at the base of the bowl protecting them from condensation or corrosion. A special sound suppression pad of 0.5 to 0.8mm thickness is integrated into the sink bowl which enables the ARGENTO Sinks to absorb excessive noise when vessels are being washed. All our ARGENTO sinks carry a warranty for 10 years against faulty workmanship and material. The ARGENTO sinks' drain pipe is specially designed to enable smooth discharge of soiled water into the drain lowering the chances of clogging. The ARGENTO sinks are available in standard bowl depths of 8, 9 and 10 inches making it easier to wash even the heavy and large vessels in your kitchen.





Advantages / Feature



Finish: All ARGENTO sinks come with a uniform European Satin Finish that aesthetically enhances the elegant design of the sink bowl.



Steel Thickness: All ARGENTO sinks are made of Stainless Steel grade 304 with a thickness of 1.2 mm. SS Grade 304 contains 18% Chrome and 8% Nickel which increases the resistance of the material to corrosion and rusting; providing extraordinary durability and unbeatable performance.



Coating: To avoid sound, the undercoat is extremely important for any Stainless Steel sink. All ARGENTO sinks are coated to about 0.5 – 0.8 mm thickness with Asphalt - a material which absorbs sound and protects the base of the sink from condensation and corrosion.



Sound Deadening Pad: In addition to the Asphalt coating, a special sound suppression pad of 2mm thickness is integrated into the ARGENTO sinks to absorb excessive noise of the Utensils during use.

Advantages / Feature

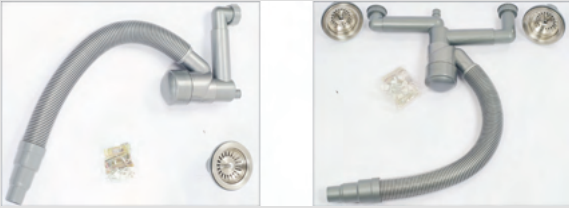

Drain Pipe: The ARGENTO series come with a Drain Pipe which is specially designed to prevent clogging and ensure easy cleaning.



Overflow Hole: The sinks also have a overflow hole that prevents accumulation of water or overflowing onto the kitchen countertop and the floor during washing and cleaning tasks.



Easy to Clean: The inherent aseptic property of stainless steel makes the maintenance of ARGENTO sinks virtually effortless. They are hygienic and easy to clean.



10 Year Warranty: *T&C Apply
All ARGENTO sinks are guaranteed for 10 years against faulty workmanship and material.



Extra Deep Bowl: ARGENTO sinks come with extra deep bowls ranging from 8 to 10 inches making it sufficiently easy to accommodate large and heavy-duty vessels for cleaning.



Topaz R 1818 - Single Bowl

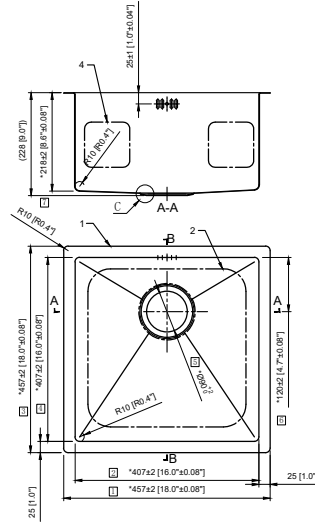

567.24.237

Overall size mm (inch): 457x457 (18" X 18")

Bowl Size mm (inch): 407x407 (16" X 16")

Depth mm (inch): 228 (9")

Topaz S 2118- Single Bowl

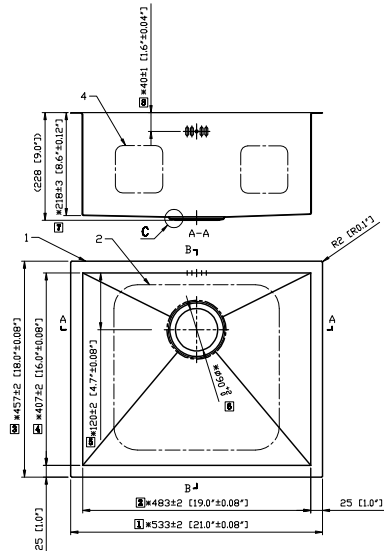

567.24.257

Overall size mm (inch): 533x457 (21" X 18")

Bowl Size mm (inch): 483x407 (19" X 16")

Depth mm (inch): 228 (9")

Topaz R 2418D - Single Bowl

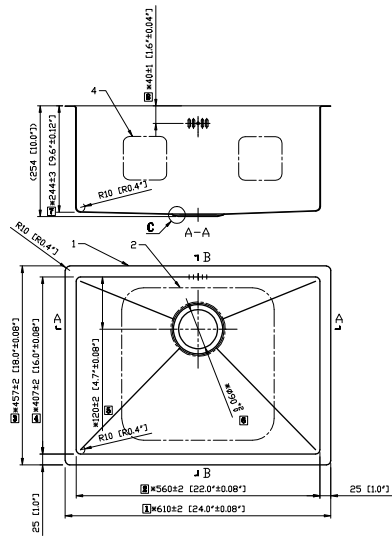

567.24.217

Overall size mm (inch): 610x457 (24" X 18")

Bowl Size mm (inch): 560x407 (22" X 16")

Depth mm (inch): 254 (10")

Topaz R 3118 - Single Bowl

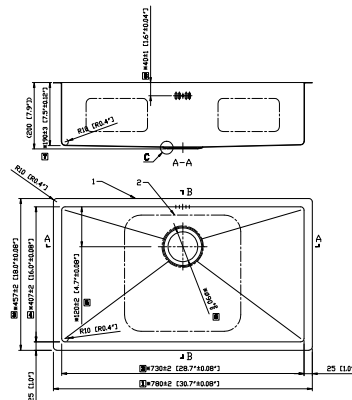

567.24.207

Overall size mm (inch): 780x457 (31" X 18")

Bowl Size mm (inch): 730x407 (29" X 16")

Depth mm (inch): 200 (8")

Emerald R 3618 - Single Bowl with DB

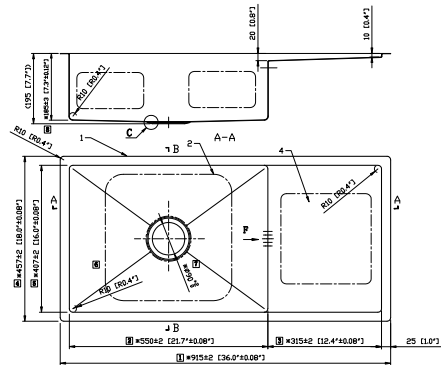

567.24.187

Overall size mm (inch): 915x457 (36" X 18")

Bowl Size mm (inch): 550x407 (22" X 16")

Depth mm (inch): 195 (8")

Sapphire R3618 - Double Bowl

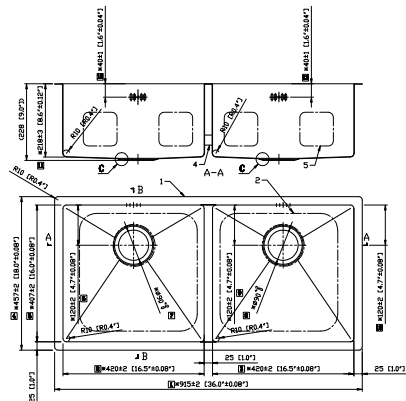

567.24.327

Overall size mm (inch): 915x457 (36" X 18")

Bowl Size mm (inch): 420x407 (17" X 16") each

Depth mm (inch): 228 (9")



Sapphire R4520 - Double Bowl

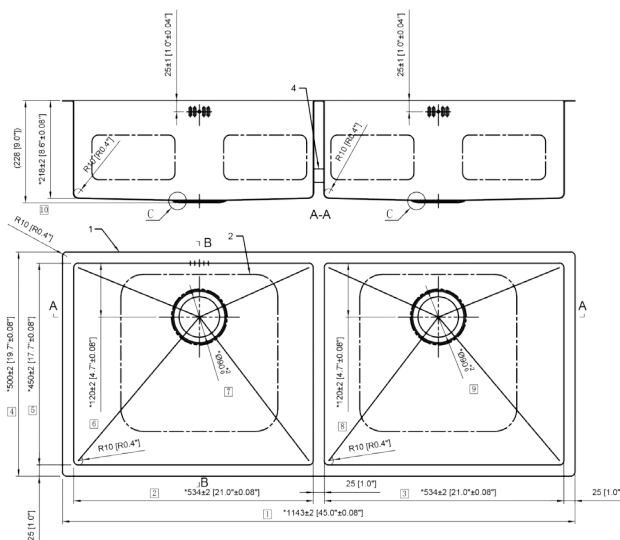

567.24.297

Overall size mm (inch): 1143 X 500 (45" X 20")

Bowl Size mm (inch): 534 X 450 (21" X 18") each

Depth mm (inch): 228 (9")



Hafele's **SPLASH** punching bowl sinks are carefully engineered through a unique drawing process where pressure is individually controlled in combination with a lubrication process which draws out the sink bowls out of a Grade 304 Stainless Steel sheet, without the steel itself breaking. The stainless steel sinks are then coated with an elegant satin finish to add a layer of protection against scratching or rusting. The well rounded shape of our SPLASH sinks makes way for easy cleaning, eliminating the chances of any unwanted residues in the remote corners of the sink bowl.

Our range of SPLASH sinks are tested to resist any external damages like chipping, cracking or peeling and the hygienic and aseptic properties of stainless steel make the maintenance of these sinks virtually effortless! The grade 304 composition of stainless steel with 18% chromium & 8% Nickel further enhances the durability of our sinks, making them highly tolerant to humid conditions. SPLASH sinks come with a special stone guard undercoating and rubber padding to absorb excessive noise levels of utensils during use. They come with a Drain Pipe of size 3.5 inches, specially designed to prevent clogging and ensure easy cleaning. SPLASH sinks come with a sink bowl depth ranging from 8 to 10 inches, making the washing of heavy-duty vessels an effortless task. All sinks from the SPLASH series come with a 2 year warranty against faulty workmanship and material.



Advantages:

Stainless Steel: Hafele SPLASH sinks use 0.8mm premium grade SUS304 stainless steel consisting of 18% chrome and 8% nickel, making the sinks highly durable and resistant to corrosion

Finish: All SPLASH sinks come with an elegant, scratch-resistant premium satin finish

Padding: The sinks are padded and Stone-Guard undercoated which reduces noise levels while the sink is in use

Bowl Depth: 8 and 10 inches bowl depths that can easily accommodate heavy vessels during any cleaning cycle

Drain System: The 3.5 inch drain outlet is compatible with most garbage disposals available in the market; it comes with a stainless steel strainer and a plastic drainage pipe

Packaging: SPLASH sinks come in a handy packaging equipped with mounting & installation brackets as well as cut-out templates

Warranty: Hafele offers a 10-years warranty (*T&C Apply) for the SPLASH range against faulty workmanship & manufacturing defect from the date of invoice

MONETA - Single Bowl Sink

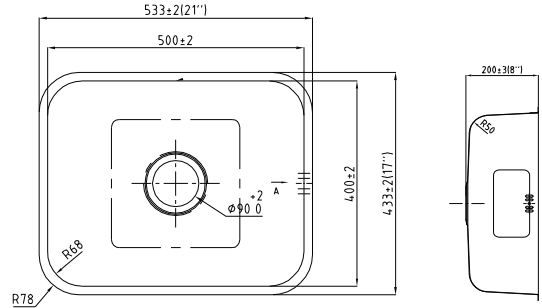

567.24.036

Overall size (mm/inch): 533x433 / 21"x17"

Bowl Size (mm/inch): 500x400 / 19"x16"

Depth (mm/inch): 200 / 8"

*Special Order

MONETA M - Single Bowl Sink

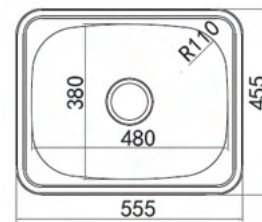

495.39.354

Overall size (mm/inch): 555*x455* / 22"x18"

Bowl Size (mm/inch): 480*x380* / 19.2"x15.2"

Depth (mm/inch): 220 / 9"

*Special Order

MONETA L - Single Bowl Sink

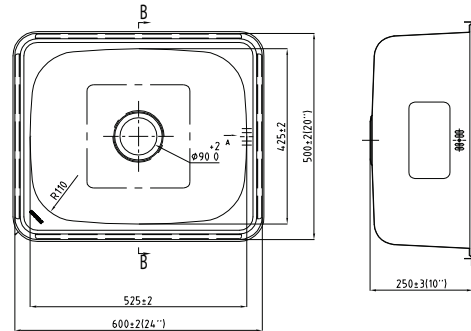

567.20.096

Overall size (mm/inch): 600x500 / 24"x20"

Bowl Size (mm/inch): 525x425 / 21"x17"

Depth (mm/inch): 250 / 10"

*Special Order

MONETA EL - Single Bowl Sink

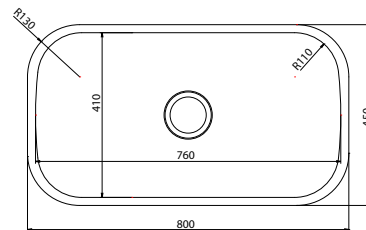

495.39.353

Overall size (mm/inch): 800x450x240 / 34"x18"x10"

Bowl Size (mm/inch): 760x410 / 31"x16"

Depth (mm/inch): 240 / 10"

*Special Order

CAMELIA - Single Bowl with Drainboard Sink

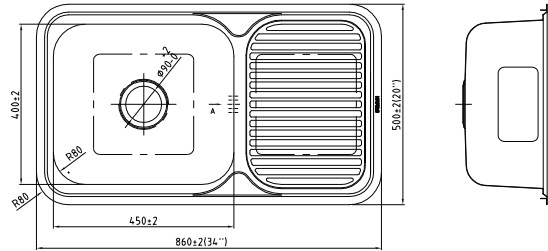

567.20.106

Overall size (mm/inch): 860x500 / 34"x20"

Bowl Size (mm/inch): 450x400 / 18"x16"

Depth (mm/inch): 210 / 8"

*Special Order

CAMELIA EL - Single Bowl with Drainboard Sink

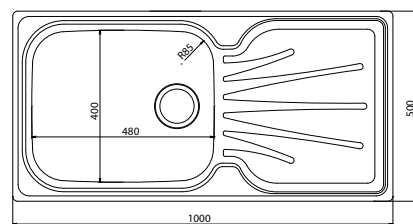

495.39.356

Overall size (mm/inch): 1000x500 / 40"x20"

Bowl Size (mm/inch): 480x400 / 19"x16"

Depth (mm/inch): 200 / 8"

*Special Order

CORAL - Double Bowl Sink

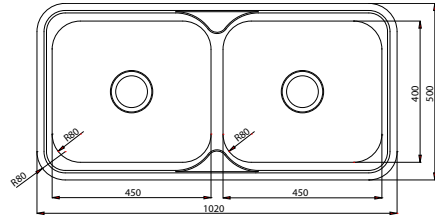
**495.39.358**

Overall size (mm/inch): 1020x500 / 40.8"x20"

Bowl Size (mm/inch): 450x400 / 18"x16"

Depth (mm/inch): 210 / 8.6"

*Special Order





We should Avoid

- The use of plastic bowls for washing, as they can cause heavy localized scratching
- Leaving salt, vinegar, citric fruit juices, mustard or pickles on the surface for any length of time as they can cause corrosion
- Abrasive cleaners such as bleach, scourers or wire wool pads

Maintenance Tips

- Frequent and regular cleaning – keep the sink clean and dry when not in use
- Expose your sink to normal room temperature when not in use
- Keep the sink free from any standing water at all possible times
- Avoid the accumulation of water high in iron content as it can leave brown stains on the sink surface
- Remove the Lacquer sheet only after installation

Things that can harm your sinks

- Do not allow any mineral deposits
- Do not use steel wool or abrasive pads to clean your sink
- Do not leave rubber dish mats, wet sponges or cleaning pads in the sink overnight
- Do not use the sink as a cutting surface or cutting board
- Do not let ordinary or white cement to deposit on the sink after installation
- Do not use household products, cleaning products, bleach or foodstuff which contains chlorine, sulphuric /hydrochloric acid as they are potentially harmful to your sink
- Pickles, mayonnaise, mustard and salt laden foodstuff should not be left on /in the sink for a long period.

**Mumbai Design Centre:**

Haji Moosa Patrawala Ind.(SOBO)
Estate, Near Famous Studio,
Mahalaxmi (West), Mumbai - 400 011
Tel.: 022 6264 7100.

Mumbai Design Centre:

#2 Filix Building, Opp. Asian Paints,
L.B.S. Marg, Bhandup (West),
Mumbai - 400 078
Tel.: 022 2596 9660/
2596 9787/2594 7305

New Delhi Office & Design Centre:

D-89 , 1st Floor, Okhla Phase-I,
New Delhi - 110 020
Tel.: 011-66574999
Fax: 011-41605482

Bangalore Office & Design Centre:

Incubex Nestavera Spaces Pvt Ltd,
No:13, Langford Place, Langford Road,
Shanti Nagar, Bangalore - 560 025
Tel.: 080 4132 6116
Fax: 080 4132 6226

Bangalore**Hafele Appliances Gallery:**

No. 2/1, Shiv Manor, Langford Road,
Shantinagar, Bangalore - 560027
Tel.: 080 - 4142 6336

Hyderabad Office & Design Centre:

SJR Building - # 1-57/89/1 & 1-57/89/2
Opp Allahabad Bank, Gachibowli,
Hyderabad – 500032
Tel.: 040 29557578 / 040 29557588

Kolkata Design Centre:

PS PACE, Premises No. 1/1A,
Mahendra Roy Lane, Topsia,
Kolkata - 700 046
Tel.: 033 40086814 / 033 40089268
Fax: 033 24988020

Kolkata Office:

Office No. 1001, PS Continental,
10th Floor, 83/2/1 Topsia Road,
Near Vishwakarma Building.
South Kolkata - 700046
Tel: 033-2285 0104 /
033-2285 0105 / 033-2285 0106

Chennai Office & Design Centre:

1st Floor No.24, College Road,
Nungambakkam, Chennai - 600 006
Tel.: 044 - 4215 1542
Fax: 044 2446 0922

Pune Design Centre:

Showroom No. 2, Ground Floor,
F P no. 403, A/2, ICC Trade Tower,
Senapati Bapat Marg,
Shivaji Nagar, Pune -411016
Tel.: 020 2563 3301
Fax: 020 2563 3302

Pune Office:

Office No. 12, Vastushree Complex,
Survey No.587,
Near Hyde Park, Gultekdi,
Market Yard, Pune - 411 037
Tel.: 020 2426 6264
Fax: 020 2426 6274

Ahmedabad Office:

Hafele India Pvt. Ltd., Office No. 302,
3rd Floor, Shangrila Arcade, Near
Shyamal Cross Road, Satellite,
Ahmedabad - 380015
Tel.: +91 79695 55505 / 8866220505

Cochin Office:

Jomer Symphony, 5th Floor, 48/1744
C34, Chalikkavattom, North Ponnuranni,
Vytila, Cochin- 682010

Sri Lanka:**Hafele Office and Design Centre:**

52, Nandana Gardens
(On Duplication Road), Colombo 04.
Tel: +94 112 500 501.
Fax: 0094 112 500 553.

Hafele Design Centre:

448, Galle Road, Rawathawatta,
Moratuwa, Sri Lanka.
Tel.: +94 112 644 600.

Hafele Design Centre:

752 Peradeniya Road,
Kandy 20000,
Sri Lanka.
Tel.: +94 812 223 338.

Bangladesh Office:

2nd Floor, House - 181, Road - 2,
Mohakhali DOHS, Dhaka - 1206.
Tel.: 01844018431/ 01844018432/
01844018433/ 01844018437.

Bangladesh Design Center:

House - 106, Road - 12,
Block - E, Banani, Dhaka - 1213
Tel.: 02-48810380-81

Nepal:

UHS Holdings Pvt. Ltd.
Address: Kathmandu-2, Gairidhara
Chowk, Nepal.
Mob.: +977 9802338800

Bhutan:

Smart Homes
Gr. Floor, Druk Building (Opp Helipad)
Babesa -Thimpu Expressway, Thimpu
Tel.: +975-2-333419
Mob.: +975-77277615, 17839717,
77114228,1760063,17669840

HÄFELE

Mumbai Corporate Office:
Office No. 3, Building "A", BETA,
I Think Techno Campus, Off J.V.L.R,
Opp. Kanjurmarg East, Mumbai – 400 042.
Tel.: 022 6142 6100 | Fax: 022 6702 0531.

For Enquiries SMS "HAFELE" to 56070
Toll Free Customer Care: 1800 266 6667
Customer Care WhatsApp: +91 97691 11122
customercare@hafeleindia.com
info@hafeleindia.com

Follow us on

