

HÄFELE



Designer
LEVER HANDLES

Foreword



Dear Customers,

Häfele has pioneered the way interior fittings are sold across the globe for many years now. Being a German company our foremost concern has always been to offer our customers products that are at the cutting edge of functionality and design; and backed by the highest standards in Customer Service. In our markets, we are increasingly being recognized as a one-stop interior specialist brand that can enable functionality for any

interior design through a holistic solution offering, be it door hardware, furniture or kitchen fittings, sliding systems, built-in appliances, bathroom solutions, furniture lighting and interior surfaces.

In the area of door hardware solutions, Häfele comes with years of experience, tradition and knowledge and offers an expansive range of solutions including hinges, door handles, door control devices, sealing systems, sliding systems and much more. All the solutions from this range come with the most superior quality, cutting-edge technology and state-of-the-art design which culminate into unparalleled functionality. We constantly add new innovations to this range after much research and development and every new solution that is added truly represents the latest trends and technologies in the market.

Likewise, this brochure unfolds Häfele's newest range of Designer Lever Handles from Europe that offers the most contemporary design options that can greatly complement the aesthetics of any interior space. All the handles from Häfele's Designer range come from Europe with the trademark Quality excellence that the continent is well known for. Every handle from this range has been carefully designed with state-of-the-art manufacturing technologies and are tested to meet the most stringent

quality standards bringing you the best product for your interior spaces. Through this range we offer you handles made from different materials namely brass and zinc-alloy; each material bringing forth its unique value propositions to your interior applications. Our Brass collection presents itself with the inherent elegance of the material that is and has been a favourite among designers and architects when it comes to interior décor. The Zinc-Alloy collection offers you the most exquisite designs to choose from that will leave even the most ordinary doors shining in style. All the handles from our brass and zinc alloy collection come in 4 exquisite finishes namely Anthracite, Champagne, Matt Black and Satin Chrome. These finishes have been carefully selected after assessing the latest interior trends worldwide to suit the most practicing colour tonalities prevalent today.

So flip through the pages of this brochure and see the different designs available with us through this range of Lever Handles. If you wish to know more you can visit us at our Design Showrooms for a better understanding and detailed dialogue. We are taking all the necessary precautions at our end to make your visit a safe and fruitful experience.

Enjoy!

A handwritten signature in white ink, appearing to read 'Jürgen Wolf'.

Jürgen Wolf
Managing Director
Häfele South Asia

Hafele

Reassuring Expertise



"For over 9 decades, we've been helping people make more of their homes."

Established in Germany, and now operating worldwide, we specialise in the fittings, hardware and systems that improve the way your home works. So when you choose our products as part of your new or reformed home, you know you're getting the benefit of extensive knowledge and decades of experience.

And we're still a family business, owned and managed by family members who really care about the products and service we provide. You can rely on our commitment to the highest standards of quality and reliability, founded on a long tradition of German engineering where attention to detail is second nature.

All our home improvement ideas are built to last – day in, day out – we want you to get the very best from every corner of your home, for many years to come."



Häfele Worldwide

With its origin in 1923 in a small town named 'Nagold' from the Swabian region of Germany that nurses a passion for hardware technology, it is no surprise that Häfele has lived up to its roots through a successful presence in the architectural and furniture hardware industry for over 9 decades now. Today, Häfele's worldwide penetration includes 38 subsidiaries across Europe, America, Asia, Australia and New Zealand. With these subsidiaries and numerous other sales organisations, Häfele operates in over 150 countries. The Häfele headquarters, 4 manufacturing units and 10 sales offices are located within Germany; while 1 manufacturing unit is located at Budapest, Hungary. The company also owns one of the largest and most sophisticated warehouses in its home country. The Häfele worldwide workforce is empowered by a base of over 8100 employees.

The group services over 150,000 customers across the globe through its extensive range of hardware products and a comprehensive logistics system. In addition to this, Häfele also provides consultative services to its customers, educating and advising them about buying the correct hardware as per their requirements. With this level of market penetration and ability to handle worldwide demand, it comes as no surprise that the company is an authority in the segment of home interior solutions; what is pleasantly surprising, though, is that in spite of its size, Häfele still remains a family owned and run business with a unique, friendly and value-centric work culture which is strongly followed among all its subsidiaries.



Hafele India

Häfele India is a wholly-owned subsidiary of the Häfele Global network and has been operating in India since 2003 under the leadership of Mr. Jürgen Wolf (Managing Director). The ability of the company to understand the diverse Indian market has made it an authority in the field of architectural hardware, furniture and kitchen fittings and accessories. The company also has a strong presence in synergized product categories namely Home Appliances, Furniture Lighting, Sanitary and Surfaces catering to the focused demand from these industries.

The subsidiary has a strong nation-wide presence with offices in Mumbai, Pune, Ahmedabad, Bangalore, Chennai, Hyderabad, Delhi, Kolkata and Cochin. It has full-scale operations in Sri Lanka and Bangladesh with Regional offices and Design Showrooms in both the countries; and has also spread its operations to other regions of South Asia including Nepal, Bhutan and Maldives.

Häfele's design showrooms are hubs of international home interior trends and cutting edge designs presented in a world-class environment, where customers can see home solutions in their inherent applications. These showrooms function as a one-stop-shop for all home interior and improvement needs - from providing in-depth technical advice to kitchen and wardrobe designing services through a team of experts stationed at the showroom.

Häfele India services its customers with a base of over 1300 employees, a well-networked Franchise base of over 130 shops along with over 1000 dealers situated across South Asia. The subsidiary has a sophisticated Logistics centre in Mumbai along with distribution centres in Delhi, Bangalore, Kolkata and Colombo respectively.



NEW BUSINESS
TRANSFORMATION
MANAGE DIRECTION
VISION POTENTIAL
COMMUNICATIONS
IMPROVEMENTS
CONSUMER
UNIQUE
PROGRESS
GROWTH IMPLEMENT
GOAL DYNAMIC
RESULTS
RENOVATION
OBJECTIVES

INNOVATIONS



CONTENTS

BRASS COLLECTION

1.	WIND	14
2.	ARCO	16
3.	ELIS	18
4.	LUIS	20
5.	DUORO	22
6.	PORTO	24
7.	CURVE	26
8.	SLOPE	28

ZINC ALLOY COLLECTION

- | | |
|-----------|----|
| 1. HYGGE | 32 |
| 2. SPRING | 34 |
| 3. BOW | 36 |
| 4. LEAN | 38 |





THE FIRST TOUCH

Every time we enter a new space, it all begins with a 'first touch' – the door handle. When we take hold of it, new spaces, expanses and whole new worlds open up to us. And so we believe that the door handle acts as a connecting element between people and spaces. For us a door handle is functional, elegant and eminently graspable – whether made of brass, zinc alloy or stainless steel.

This brochure takes you through Häfele's range of Designer Lever Handles that make your experience of the 'first touch' the most memorable one. Available in a host of designs, this range has been carefully put together to offer you maximum flexibility and choice while designing your interior spaces. The range includes the choicest of designs from Manital, an Italian manufacturer of lever handles and a favourite brand among Interior Designers and Architects world over. With Manital and the exquisite in-house range from Häfele, we present you an offering that will definitely give you what you want.

EUROPEAN QUALITY ASSURANCE

All the handles from Hafele's Designer range come from Europe with the trademark Quality excellence that the continent is well known for. Every handle from this range has been carefully designed with state-of-the-art manufacturing technologies and are tested to meet the most stringent quality standards bringing you the best product for your interior spaces.

MATERIAL

Through this range we offer you handles made from different materials namely brass and zinc-alloy; each material bringing forth its unique value propositions to your interior applications. Our Brass collection presents itself with the inherent elegance of the material that is and has been a favourite among designers and architects when it comes to interior décor. The Zinc-Alloy collection offers you the most exquisite designs to choose from that will leave even the most ordinary doors shining in style.

FINISH

All the handles from our brass and zinc alloy collection come in 4 exquisite finishes namely Anthracite, Champagne, Matt Black and Satin Chrome. These finishes have been carefully selected after assessing the latest interior trends worldwide to suit the most practicing colour tonalities prevalent today.

DESIGN

Hafele's Designer Lever Handles from the brass and zinc alloy collections, offer you 12 unique and contemporary designs encompassing the artistic fluidity of nature. Inspired by the organic shapes and forms of landscapes, winds and changing horizons, these handles present themselves as a truly exquisite range.

SLIM ROSE AND ESCUTCHEON

Hafele's in-house range of Designer Lever Handles comes with a Slimline rose and escutcheon design with a thickness of 5mm, a novelty as against the market standard of 10mm. The lean 5 mm rose adds to the overall aesthetic value of these handles. The Rose also comes with an integrated spring that brings the handle to its original position automatically after use – a novelty that other handles in the market lack and hence rely on the spring of the mortise lock which may or may not serve this purpose adequately.

WARRANTY



Hafele offers a 5 years functional warranty on its range of lever handles against any operational issues that can be attributed to factory faults. Any damages arising out of incorrect installation or poor handling of the handles, will not be covered under this warranty service.

AWARDS

Hafele's range boasts of the Hygge Lever Handle by Manital that has been globally recognized for its unique design and has been awarded the Red Red dot design award 2018 and BigSEE 2019 award.



red dot





WHAT IF...
GRASPING AND UNDERSTANDING
WERE SIMULTANEOUS?

BRASS

COLLECTION

A material that has been a favourite among designers for many years owing to its inherent sophistication and ability to execute aesthetic and ever-lasting designs.

Häfele's brass collection of Designer Lever Handles offers you choices of aesthetic designs and finishes that could ordain even the most ordinary doors with style.

HAFELE

*A wave of artistic projection that
embodies the cool wind*



WIND

BY MANITAL



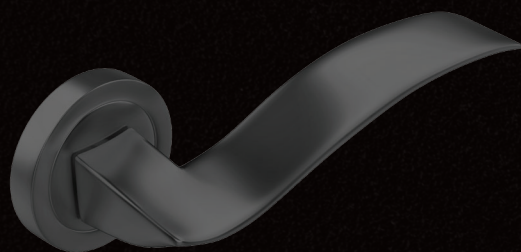

FINISH MATT BLACK

ARTICLE NO. 901.99.630



FINISH SATIN CHROME

ARTICLE NO. 900.92.459*

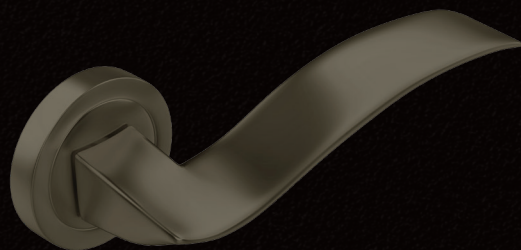

FINISH ANTHRACITE

ARTICLE NO. 901.99.631

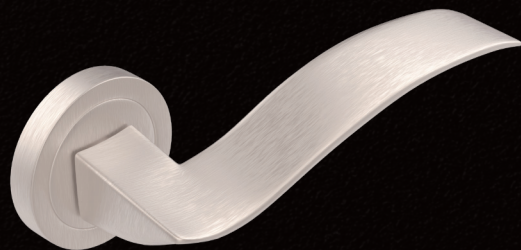

FINISH CHAMPAGNE

ARTICLE NO. 901.78.480*

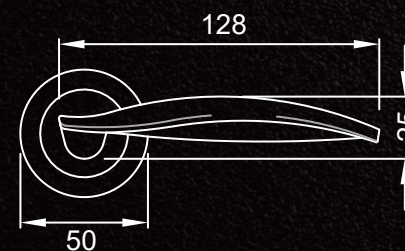

*SPECIAL ORDER

HAFELE

*An easy arc bend that executes
style and finesse*

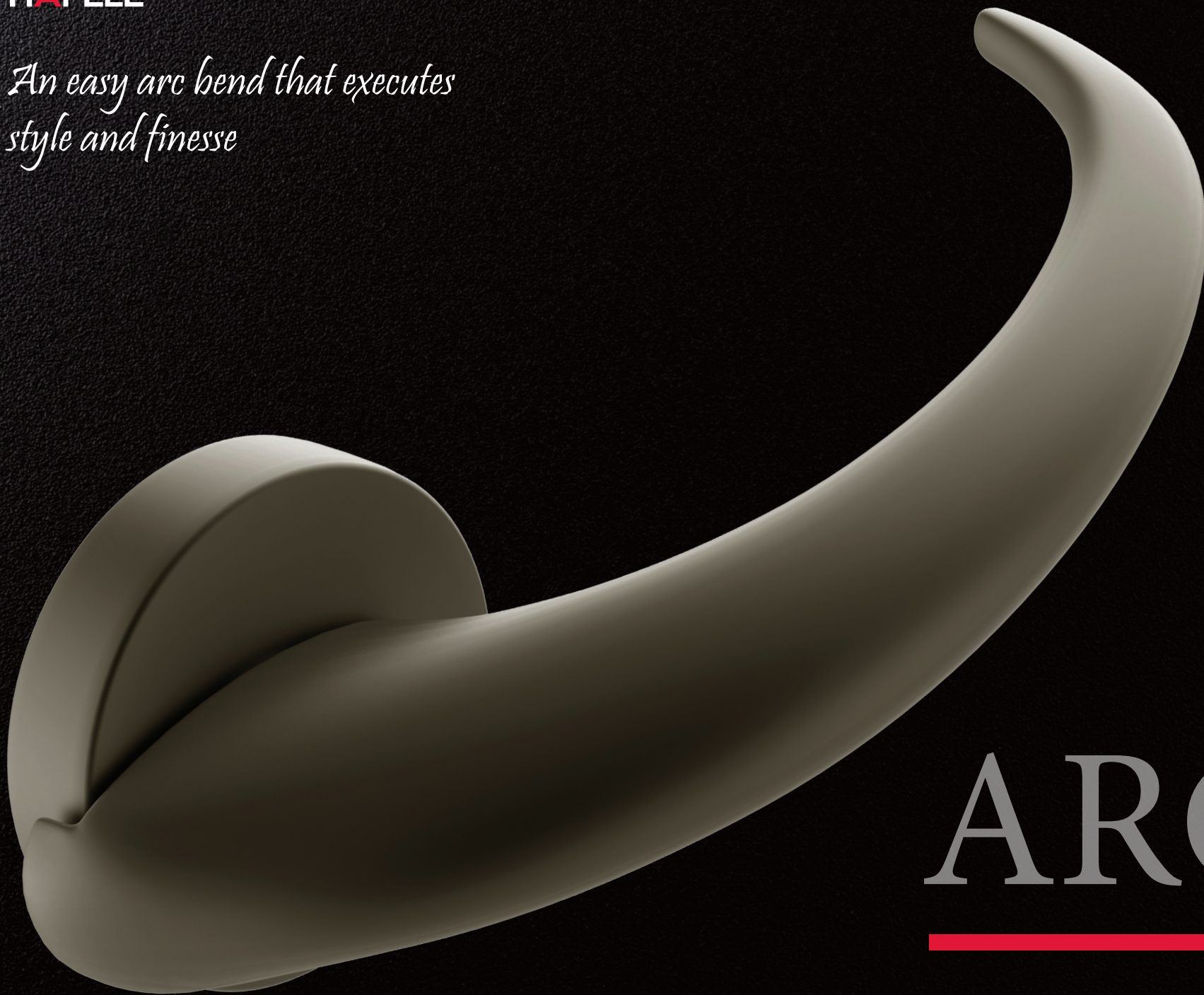

ARCO

BY MANITAL



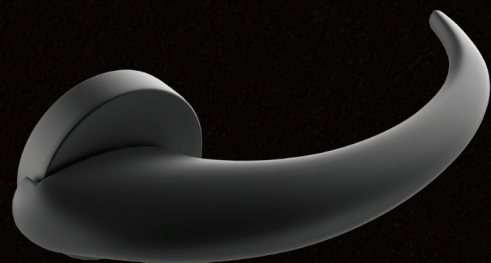

FINISH MATT BLACK

ARTICLE NO. 901.99.848



FINISH SATIN CHROME

ARTICLE NO. 901.99.849*

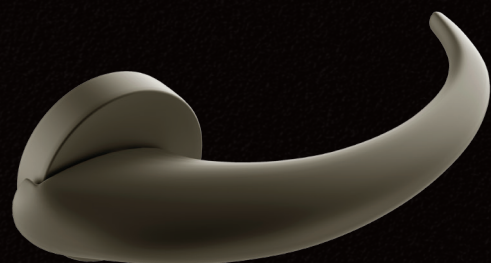

FINISH ANTHRACITE

ARTICLE NO. 901.99.850*



FINISH CHAMPAGNE

ARTICLE NO. 901.99.851

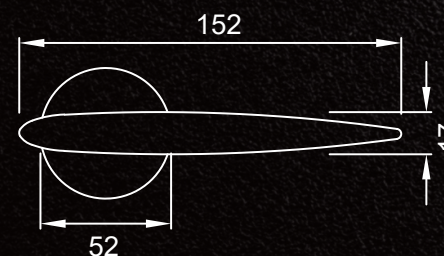

*SPECIAL ORDER

HAFELE

*A unique angular design that
shouts elegance*



ELIS
BY MANITAL

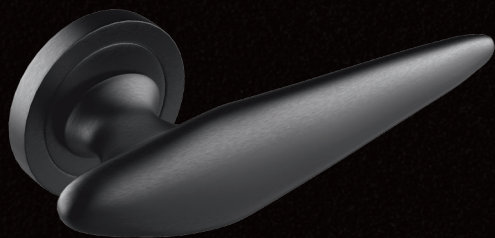

FINISH MATT BLACK

 ARTICLE NO. 901.99.852



FINISH SATIN CHROME

 ARTICLE NO. 901.99.853*

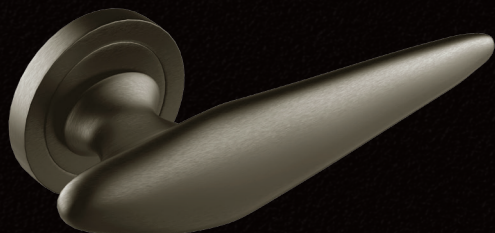

FINISH ANTHRACITE

 ARTICLE NO. 901.99.855

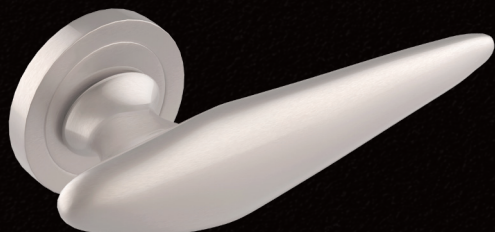

FINISH CHAMPAGNE

 ARTICLE NO. 901.99.854*

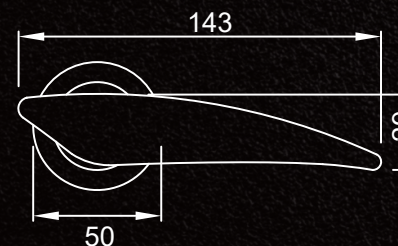

*SPECIAL ORDER

HAFELE

*A sharp neat cut that continues
into a fluid linear design*



LUIS



FINISH MATT BLACK

 ARTICLE NO. 900.78.287*



FINISH SATIN CHROME

 ARTICLE NO. 900.78.284

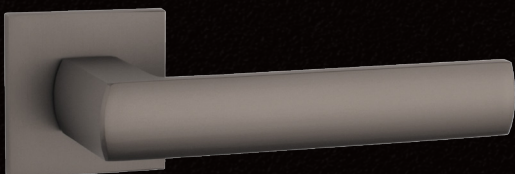

FINISH ANTHRACITE

 ARTICLE NO. 900.78.285

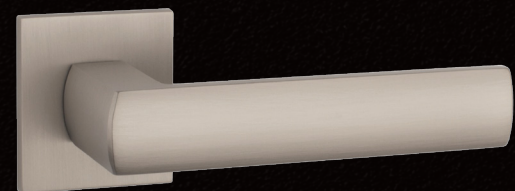

FINISH CHAMPAGNE

 ARTICLE NO. 900.78.286*

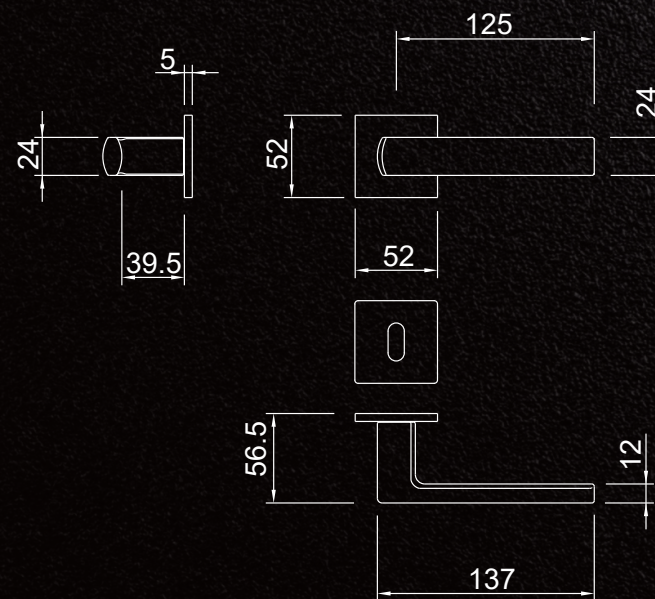

WITH SLIM ROSE & ESCUTCHEON

*SPECIAL ORDER

HAFELE

*An exceptional combination of
curves and lines*



DUORO

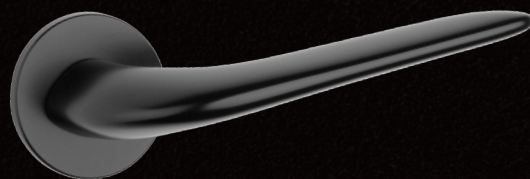

FINISH MATT BLACK

ARTICLE NO. 900.78.291*



FINISH SATIN CHROME

ARTICLE NO. 900.78.288

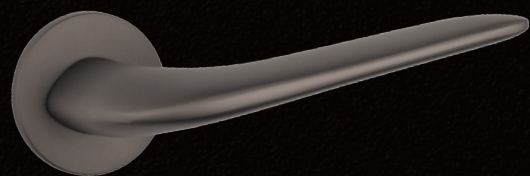

FINISH ANTHRACITE

ARTICLE NO. 900.78.289



FINISH CHAMPAGNE

ARTICLE NO. 900.78.290*

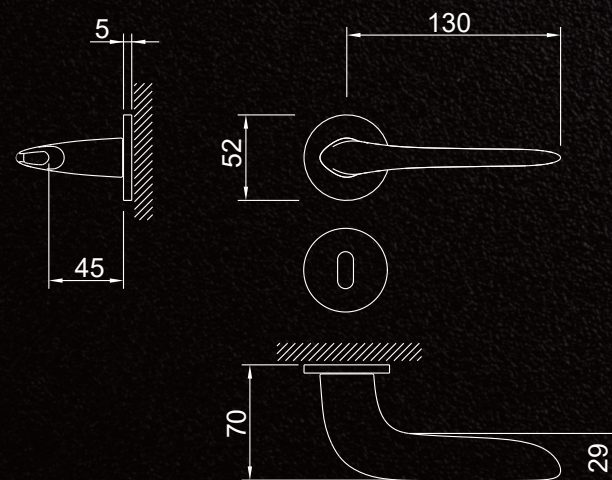

WITH SLIM ROSE & ESCUTCHEON

*SPECIAL ORDER

HAFELE

*A symmetric design that continues
into perfection*



PORTO

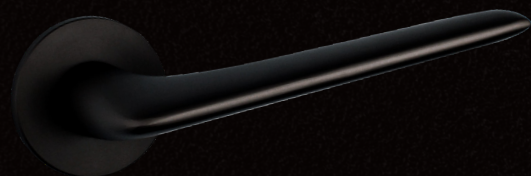

FINISH MATT BLACK

ARTICLE NO. 900.78.295

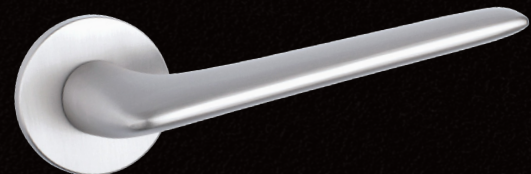

FINISH SATIN CHROME

ARTICLE NO. 900.78.292*

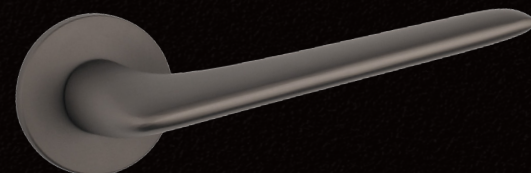

FINISH ANTHRACITE

ARTICLE NO. 900.78.293*

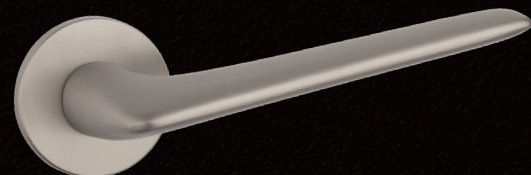

FINISH CHAMPAGNE

ARTICLE NO. 900.78.294

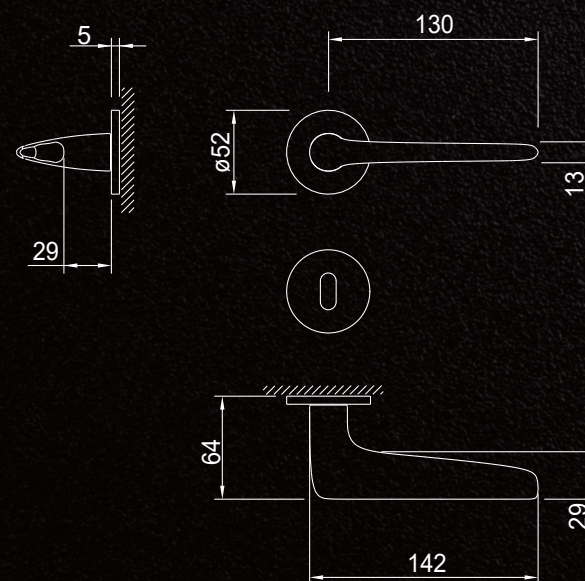

WITH SLIM ROSE & ESCUTCHEON

*SPECIAL ORDER

HAFELE

*A sinuous design that starts and
ends in smooth curves*



CURVE

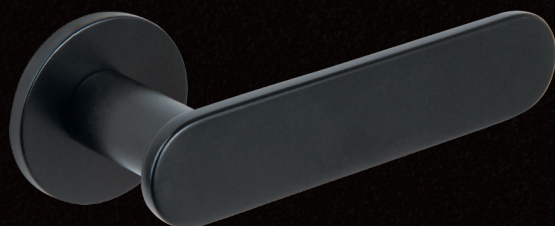

FINISH MATT BLACK

ARTICLE NO. 900.78.299



FINISH SATIN CHROME

ARTICLE NO. 900.78.296*



FINISH ANTHRACITE

ARTICLE NO. 900.78.297



FINISH CHAMPAGNE

ARTICLE NO. 900.78.298

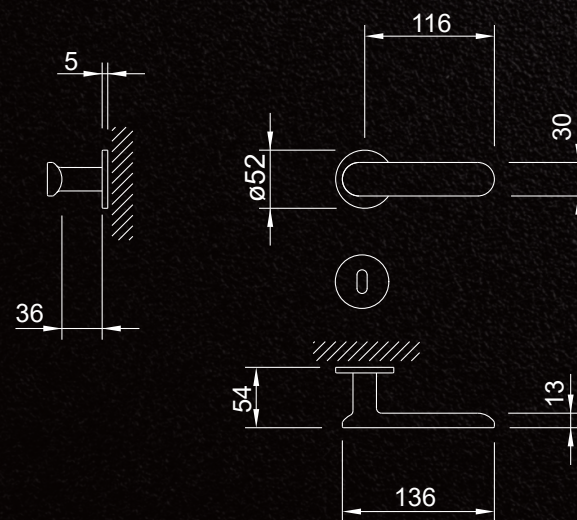

WITH SLIM ROSE & ESCUTCHEON

*SPECIAL ORDER

HAFELE

*A contemporarily angular design
that redefines individuality*

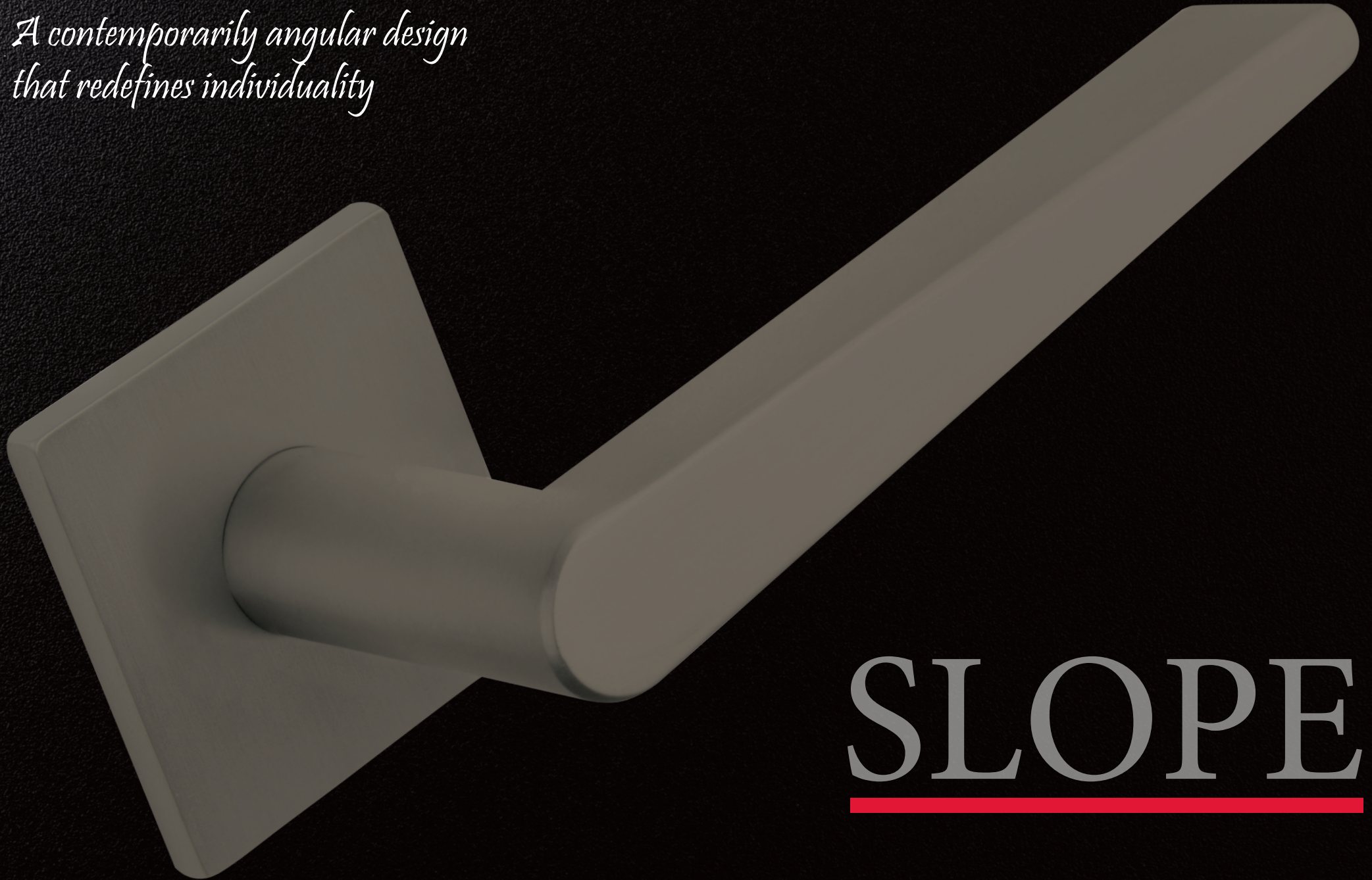

SLOPE

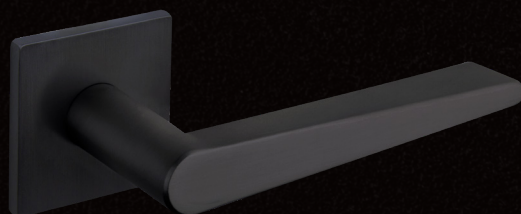

FINISH MATT BLACK

ARTICLE NO. 900.78.303



FINISH SATIN CHROME

ARTICLE NO. 900.78.300

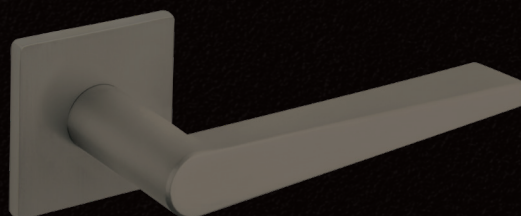

FINISH ANTHRACITE

ARTICLE NO. 900.78.301*



FINISH CHAMPAGNE

ARTICLE NO. 900.78.302*

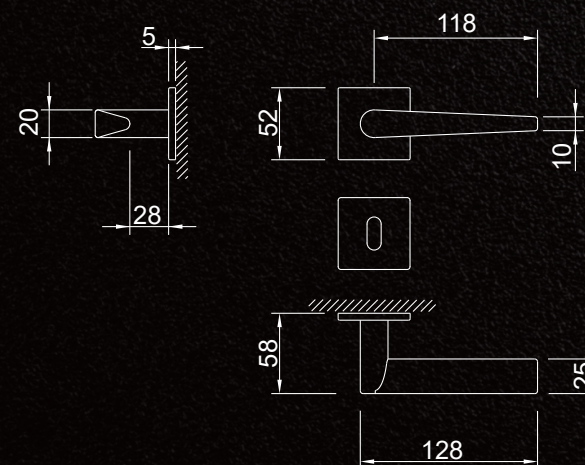

WITH SLIM ROSE & ESCUTCHEON

*SPECIAL ORDER



WHAT IF...YOU FOUND SUPPORT
WHILE HOLDING?

ZINC ALLOY COLLECTION

Häfele's Zinc-alloy collection of Premium Lever Handles offers you the most exquisite designs in smooth and elegant finishes. These handles can execute the most artistic renditions on the main and internal doors of homes, hotels or villas.

HAFELE

*A delicate straight design that
exemplifies sophistication*

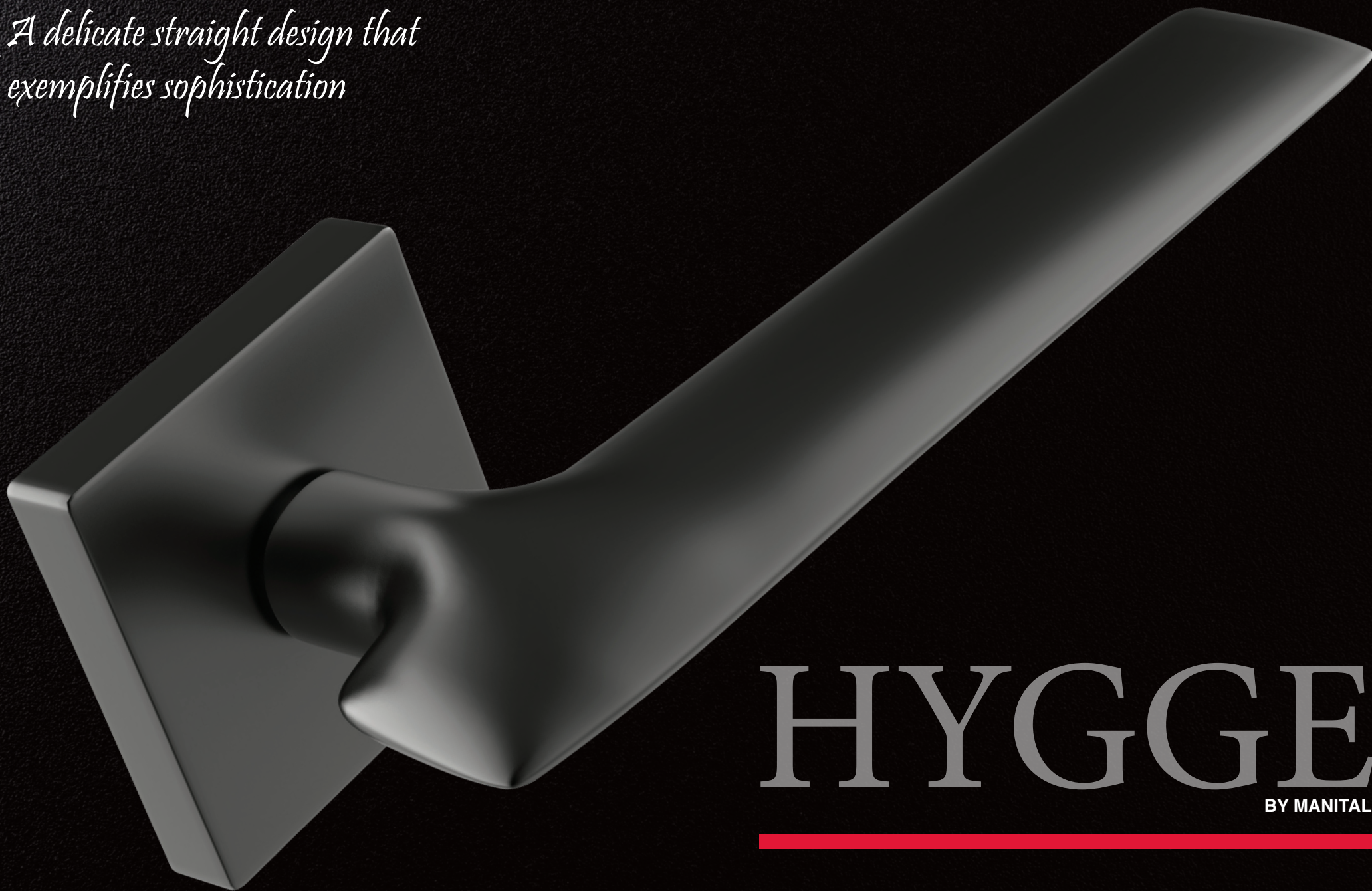

HYGGGE

BY MANITAL



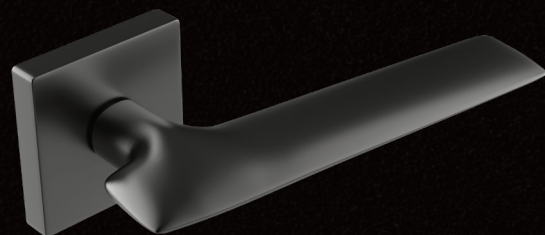

FINISH MATT BLACK

ARTICLE NO. 901.99.624

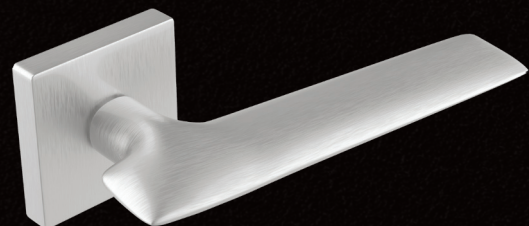

FINISH SATIN CHROME

ARTICLE NO. 901.99.625

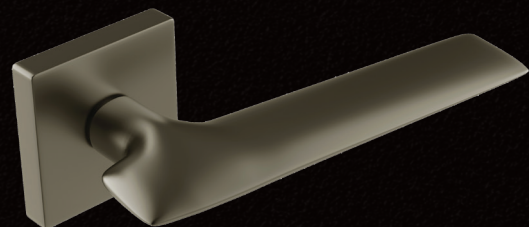

FINISH ANTHRACITE

ARTICLE NO. 901.99.626

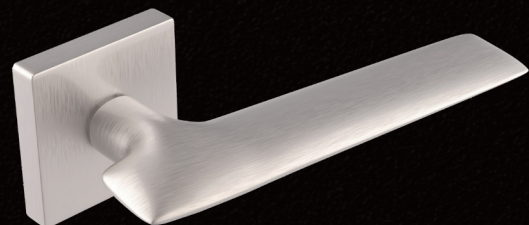

FINISH CHAMPAGNE

ARTICLE NO. 901.99.627*

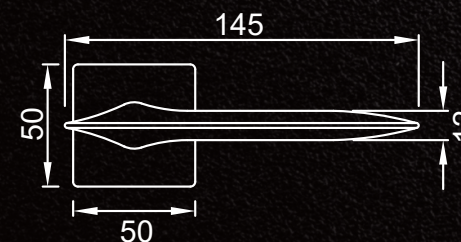

*SPECIAL ORDER

HAFELE

*A bold sturdy design that projects
strength and attitude*



SPRING

BY MANITAL



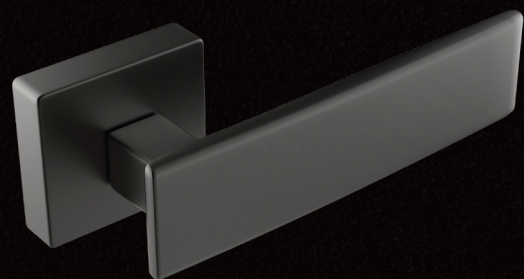

FINISH MATT BLACK

ARTICLE NO. 900.92.503

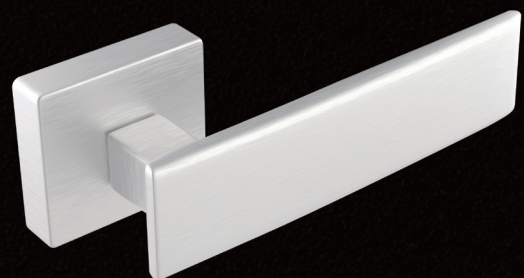

FINISH SATIN CHROME

ARTICLE NO. 900.92.500*

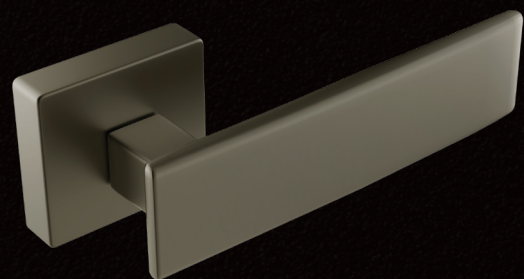

FINISH ANTHRACITE

ARTICLE NO. 901.99.628

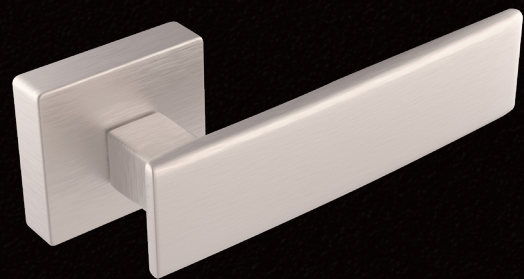

FINISH CHAMPAGNE

ARTICLE NO. 901.99.629*



*SPECIAL ORDER

HAFELE

*A seamlessly arching design that
ends in clean slender*



BOW



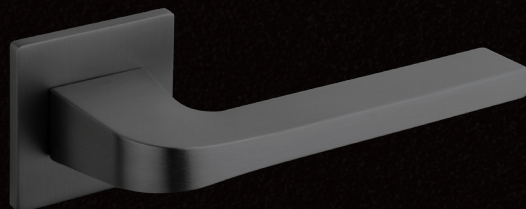

FINISH MATT BLACK
 ARTICLE NO. 900.78.307



FINISH SATIN CHROME
 ARTICLE NO. 900.78.304

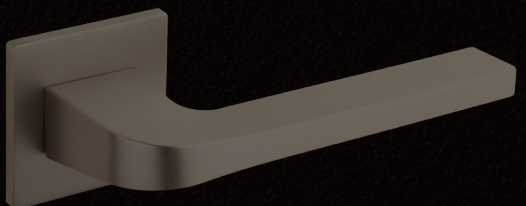

FINISH ANTHRACITE
 ARTICLE NO. 900.78.305



FINISH CHAMPAGNE
 ARTICLE NO. 900.78.306*

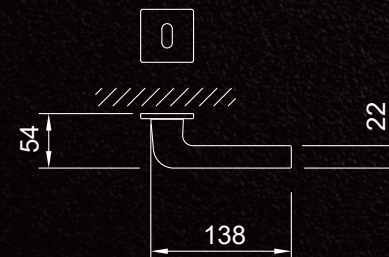
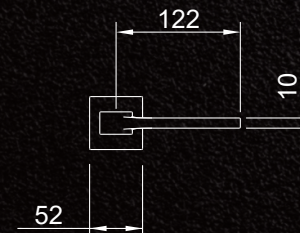

WITH SLIM ROSE & ESCUTCHEON

*SPECIAL ORDER

HAFELE

*A slim and well-postured design that
offers perfect symmetry*



LEAN



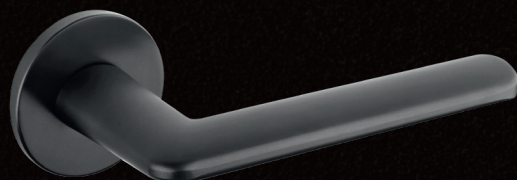

FINISH MATT BLACK

ARTICLE NO. 900.78.311



FINISH SATIN CHROME

ARTICLE NO. 900.78.308

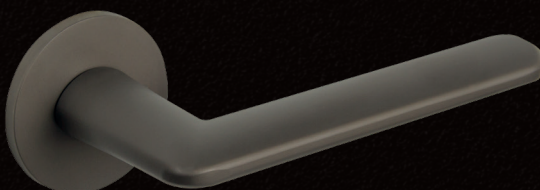

FINISH ANTHRACITE

ARTICLE NO. 900.78.309



FINISH CHAMPAGNE

ARTICLE NO. 900.78.310*

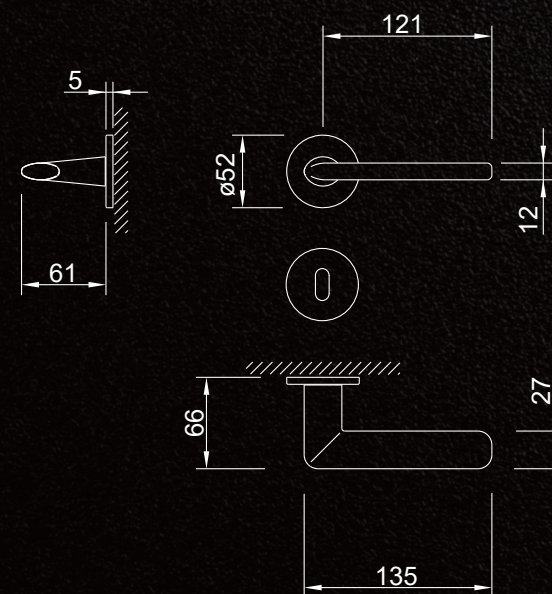

WITH SLIM ROSE & ESCUTCHEON

*SPECIAL ORDER

Guidelines for installing the Slim Line Rose and Escutcheon:

Häfele's in-house range of Designer Lever Handles comes with an exceptionally slim design (5 mm) for the rose and escutcheon – a sheer novelty among lever handle designs in the market, today. Here are few guidelines that should be followed while installing these handles:

- ⇒ Position the 8mm square spindle. (Reference “1” in the figure)
- ⇒ Position the adapter with the ‘through holes’. (Reference “2” in the figure)
- ⇒ Position the adapter with the ‘thread’. (Reference “3” in the figure)
- ⇒ Adjust and thread in the two ‘M4 screws’. (Reference “4” in the figure)
- ⇒ Break and remove the central “square” portion of both the plastic adapters. (Reference “5” in the figure)
- ⇒ Apply the two handles with the plate bottom up, adjust the alignment and then press them against the door until you hear a “CLICK” sound. (Reference “6” & “7” in the figure)
- ⇒ Tighten the “M6 threaded pins” against the square spindle. (Reference “8” in the figure)

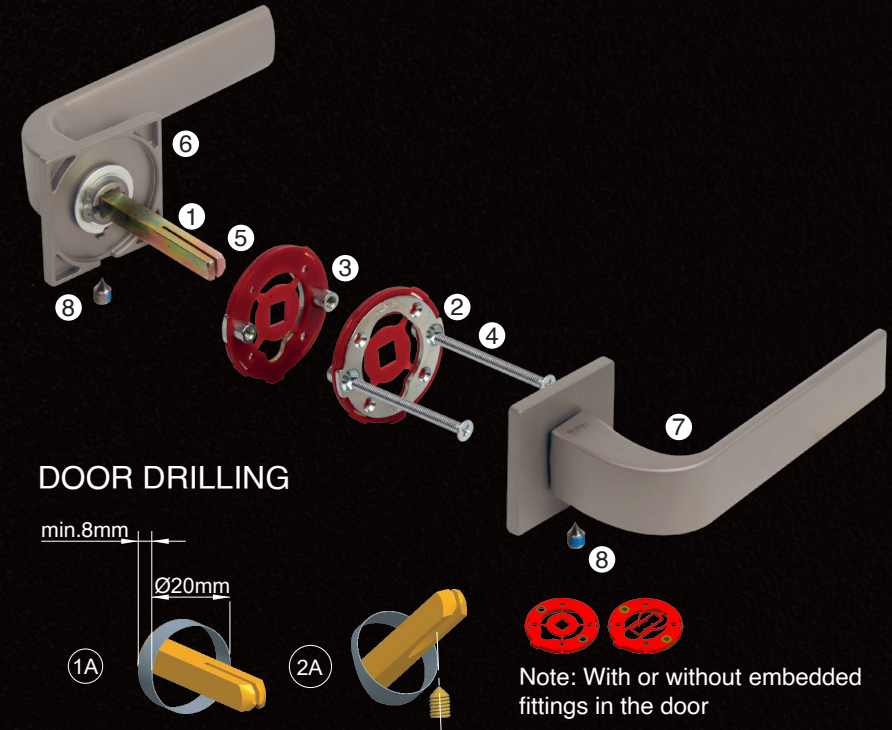

Do's & Don'ts

DO'S

1. Ensure that the product is installed correctly and as per the installation protocols suggested by our technical team.
2. Contact our toll free Customer Care Team for free installation guidance.
3. Use appropriate tools and jigs for installation.
4. Adhere strictly to the CARE instructions provided
5. Wipe regularly with a dry soft cloth.

DON'TS

1. Do not customize the product installation as this could hamper the product functionality. Adhere to HÄFELE specifications, strictly.
2. Do not tamper with and/or misuse the product
3. Do not use a masking tape to cover the product as it damages the finish and leaves marks that are difficult to clean.
4. Do not use any type of detergent, chemical, acidic or wet substance to clean the product



Hafele's Specifications Team Walks with you at every step of your project.

Every project has different product requirements depending on the size, type, location and application it is intended for. To fulfil the hardware requirements of these projects to the best possible level, you need an expert that will guide you through the process and help you meet all requirements without compromising on the integrity of your design. Häfele's Specification team intends to do just that so you can relax and get a peace-of-mind experience with our 360° comprehensive solutions and services. We can cater to your varying needs with a specialist range of products including electronic access control systems, automatic sliding door

solutions, innovative movable walls, contactless/ sensor-based furniture lighting and sanitary products as well as a vast collection of essential architectural/ furniture hardware among many.

Our DipGAI certified team and specification consultants have years of experience in the industry. We offer specifications, comprehensive scheduling, product and solution recommendations and quotation service for all our systems, and the best possible professional and technical expertise in all types of projects.

**Mumbai Design Centre:**

Haji Moosa Patrawala Ind.(SOBO)
Estate, Near Famous Studio,
Mahalaxmi (West), Mumbai - 400 011
Tel.: 022 6264 7100.

Mumbai Design Centre:

#2 Filix Building, Opp. Asian Paints,
L.B.S. Marg, Bhandup (West),
Mumbai - 400 078
Tel.: 022 2596 9660/
2596 9787/2594 7305

New Delhi Office & Design Centre:

D-89 , 1st Floor, Okhla Phase-I,
New Delhi - 110 020
Tel.: 011-66574999
Fax: 011-41605482

Bangalore Office & Design Centre:

Incubex Nestavera Spaces Pvt Ltd,
No:13, Langford Place, Langford Road,
Shanti Nagar, Bangalore - 560 025
Tel.: 080 4132 6116
Fax: 080 4132 6226

Sri Lanka:**Hafele Office and Design Centre:**

52, Nandana Gardens
(On Duplication Road), Colombo 04.
Tel: +94 112 500 501.
Fax: 0094 112 500 553.

Hafele Design Centre:

448, Galle Road, Rawathawatta,
Moratuwa, Sri Lanka.
Tel.: +94 112 644 600.

Hafele Boutique:

747A, Sirimawo Bandaranayaka
Mawatha, Mulgampola,
Kandy, Sri Lanka.
Tel.: +94 812 223 338.

Bangalore**Hafele Appliances Gallery:**

No. 2/1, Shiv Manor, Langford Road,
Shantinagar, Bangalore - 560027
Tel.: 080 - 4142 6336

Hyderabad Office & Design Centre:

SJR Building - # 1-57/89/1 & 1-57/89/2
Opp Allahabad Bank, Gachibowli,
Hyderabad – 500032
Tel.: 040 29557578 / 040 29557588

Kolkata Design Centre:

PS PACE, Premises No. 1/1A,
Mahendra Roy Lane, Topsis,
Kolkata - 700 046
Tel.: 033 40086814 / 033 40089268
Fax: 033 24988020

Kolkata Office:

Office No. 1001, PS Continental,
10th Floor, 83/2/1 Topsis Road,
Near Vishwakarma Building.
South Kolkata - 700046
Tel: 033-2285 0104 /
033-2285 0105 / 033-2285 0106

Bangladesh Office:

2nd Floor, House - 181, Road - 2,
Mohakhali DOHS, Dhaka - 1206.
Tel.: 01844018431/ 01844018432/
01844018433/ 01844018437.

Bangladesh Design Center:

House - 106, Road - 12,
Block - E, Banani, Dhaka - 1213
Tel.: 02-48810380-81

Nepal:

UHS Holdings Pvt. Ltd.
Kathmandu-2, Gairidhara Chowk, Nepal.
Mob.: +977 9802338800

Chennai Office & Design Centre:

1st Floor No.24, College Road,
Nungambakkam, Chennai - 600 006
Tel.: 044 - 4215 1542
Fax: 044 2446 0922

Pune Design Centre:

Showroom No. 2, Ground Floor,
F P no. 403, A/2, ICC Trade Tower,
Senapati Bapat Marg,
Shivaji Nagar, Pune -411016
Tel.: 020 2563 3301
Fax: 020 2563 3302

Pune Office:

Office No. 12, Vastushree Complex,
Survey No.587,
Near Hyde Park, Gultekdi,
Market Yard, Pune - 411 037
Tel.: 020 2426 6264
Fax: 020 2426 6274

Bhutan:

SMART HOMES
Gr. Floor, Druk Building (Opp Helipad)
Babesa -Thimpu Expressway, Thimpu
Tel.: +975-2-333419
Mob.: +975-77277615, 17839717,
77114228,1760063,17669840

Ahmedabad Office:

Hafele India Pvt. Ltd., Office No. 302,
3rd Floor, Shangrila Arcade, Near Shyamal
Cross Road, Satellite,
Ahmedabad - 380015
Tel.: +91 79695 55505 / 8866220505

Cochin Office:

Jomer Symphony, 5th Floor, 48/1744
C34, Chalikkavattom, North Ponnuranni,
Vyttila, Cochin- 682010

HAFELE

Mumbai Corporate Office:

Office No. 3, Building "A", BETA,
I Think Techno Campus, Off J.V.L.R.,
Opp. Kanjurmarg East, Mumbai – 400 042.
Tel.: 022 6142 6100 | Fax: 022 6702 0531.

For Enquiries SMS "HAFELE" to 56070

Toll Free Customer Care: 1800 266 6667
Customer Care WhatsApp: +91 97691 11122
customer care@hafeleindia.com
info@hafeleindia.com

Follow us on

